



Workshop Manual

chassis

SUPPLEMENT

3000GT '99

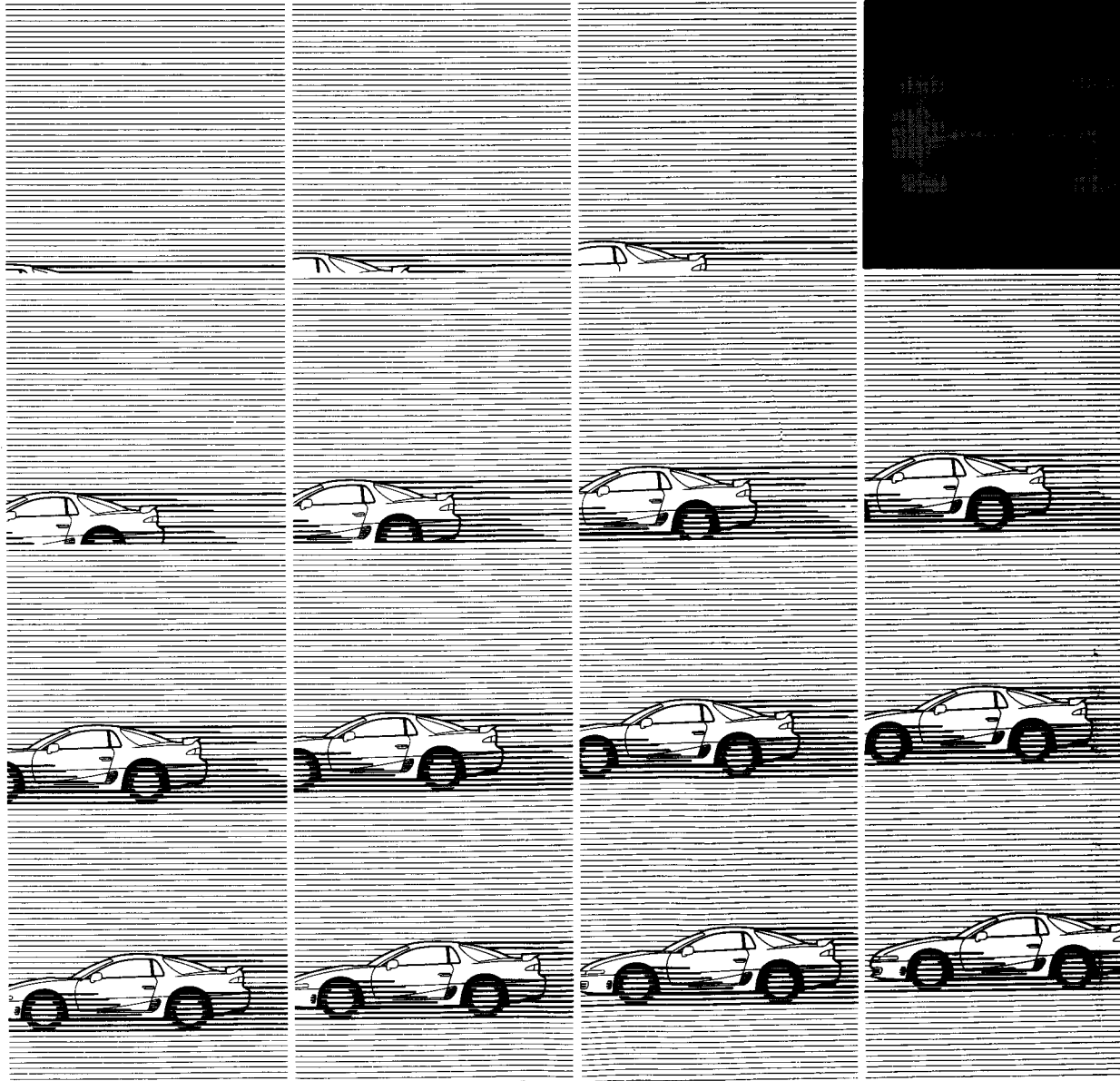

Pub. No. PWUE9119-H

Pub. No. PWUE9203-6

MITSUBISHI 3000GT

WORKSHOP MANUAL SUPPLEMENT

General	00
Fuel	13
Chassis Electrical	54

FOREWORD

This Workshop Manual contains procedures for removal, disassembly, inspection, adjustment, reassembly and installation, etc. for service mechanics. Use the manuals indicated on the following page in combination with this manual as required.

All information, illustrations and product descriptions contained in this manual are current as at the time of publication. We, however, reserve the right to make changes at any time without prior notice or obligation.



RELATED PUBLICATIONS

TECHNICAL INFORMATION MANUAL

WORKSHOP MANUAL

Chassis Group
<Europe>

<General Export, GCC and
Australia>

Engine Group

ELECTRICAL WIRING

<Europe>

<General Export, GCC and
Australia>

PARTS CATALOGUE

<Europe>
<General Export, GCC>

PYUE9201

PWUE9119 (Loose-leaf edition)
PWUE9119-E (Supplement)
PWUE9119-F (Supplement)
PWUE9119-G (Supplement)
PWUE9119 (Loose-leaf edition)
PWUE9203 (Basic)
PWUE9203-1 (Supplement)
PWUE9203-2 (Supplement)
PWUE9203-3 (Supplement)
PWUE9203-4 (Supplement)
PWUE9203-5 (Supplement)
PWEE□□□□ (Loose-leaf edition)

PHUE9201 (Loose-leaf edition)
PHUE9201-D (Supplement)
PHUE9201-E (Supplement)
PHUE9201-F (Supplement)
PHUE9201-G (Supplement)
PHUE9406 (Basic)
PHUE9406-1 (Supplement)
PHUE9406-2 (Supplement)
PHUE9406-3 (Supplement)

B608K408A□
B808K408A□

WARNINGS REGARDING OF SUPPLEMENTAL RESTRAINT SYSTEM (SRS) EQUIPPED VEHICLES

WARNING!

- (1) Improper service or maintenance of any component of the SRS, or any SRS-related component, can lead to personal injury or death to service personnel (from inadvertent firing of the air bag) or to the driver (from rendering the SRS inoperative).
- (2) If it is possible that the SRS components are subjected to heat over 93°C (200°F) in baking or in drying after painting, remove the SRS components (air bag module, SRS-ECU) beforehand.
- (3) Service or maintenance of any SRS component or SRS-related component must be performed only at an authorized MITSUBISHI dealer.
- (4) MITSUBISHI dealer personnel must thoroughly review this manual, and especially its GROUP 52B – Supplemental Restraint System (SRS), before beginning any service or maintenance of any component of the SRS or any SRS-related component.

GENERAL 00

GENERAL

VEHICLE IDENTIFICATION

MODEL

VEHICLES FOR EUROPE

Model code	Engine model	Transmission model	Fuel supply system
Z16AMJGFL6	6G72 (2,972 ml)	W6MG1	MPI
Z16AMJGFR6			

VEHICLES FOR GENERAL EXPORT

Model code	Engine model	Transmission model	Fuel supply system
Z16AMNGFL	6G72 (2,972 ml)	W5MG1	MPI
Z16AMNGFR			

VEHICLES FOR GCC

Model code	Engine model	Transmission model	Fuel supply system
Z16AMNGFLW	6G72 (2,972 ml)	W5MG1	MPI

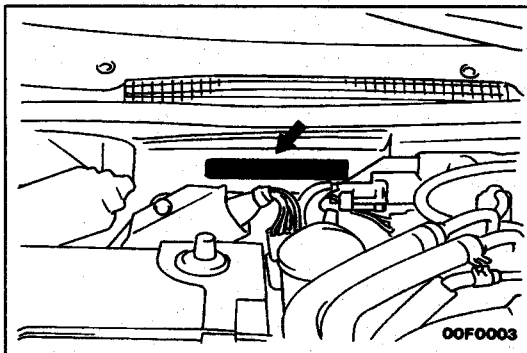

CHASSIS NUMBER

The chassis number is stamped on the toeboard inside the engine compartment.

▲	J	M	B	M	N	Z16	A	X	Y	000001	▲
	1	2	3	4	5	6	7	8	9	10	

V0207AA

- | | |
|--|--|
| <p>1. Asia</p> <p>2. Japan</p> <p>3. MITSUBISHI
 A – For Europe, right hand drive
 B – For Europe, left hand drive
 Y – For General Export or GCC</p> <p>4. Body style
 M – 2-door hatchback</p> <p>5. Transmission type
 N – 5-speed manual transmission
 J – 6-speed manual transmission</p> | <p>6. Development order
 Z16 – 2,972 ml (Full time 4WD)</p> <p>7. Sort
 A – Passenger car</p> <p>8. Model year
 X – 1999</p> <p>9. Plant
 Y – Ohe Motor Vehicle Works</p> <p>10. Serial number</p> |
|--|--|

FUEL

CONTENTS

GENERAL	2	Ignition Switch-ST	21
Outline of Changes	2	Vehicle Speed Sensor	22
SPECIFICATIONS	2	Power Steering Fluid Pressure Switch	24
General Specifications	2	Air Conditioner Switch and Power Relay	25
TROUBLESHOOTING	2	Detonation Sensor	26
ON-VEHICLE INSPECTION OF MPI		Electrical Load Switch	27
COMPONENTS	3	Oxygen Sensor	28
Power Supply and Ignition Switch-IG	3	Fan Motor Relay (Radiator Fan, Condenser Fan)	30
Engine Control Unit Power Earth	4	Injectors	32
Fuel Pump	5	Idle Speed Control Servo (Stepper Motor Type)	33
Air Flow Sensor	8	Ignition Coil and Power Transistor	34
Intake Air Temperature Sensor	10	Purge Control Solenoid Valve	37
Barometric Pressure Sensor	11	EGR Control Solenoid Valve	38
Engine Coolant Temperature Sensor	13	Fuel Pressure Control Valve	39
Throttle Position Sensor	14	Waste Gate Control Solenoid Valve	40
Idle Position Switch	16	Boost Meter	41
Cam Position Sensor	17	Anti-lock Braking Signal	42
Crank Angle Sensor	19	Terminal Voltage Check Chart	42

GENERAL

OUTLINE OF CHANGES

- The engine-ECU in the vehicle for Europe has been changed as follows. Service procedures for areas which are different from before have been established to correspond to this.
 - (1) The engine-ECU connector terminal layout has been changed to correspond to changes in the inhibitor system.

SPECIFICATIONS

GENERAL SPECIFICATIONS

Items	Specifications
Engine control unit identification model No. LHD RHD	E2T61492 E2T61491

TROUBLESHOOTING

NOTE

Replace the engine-ECU together with the immobilizer-ECU and ignition key.

ON-VEHICLE INSPECTION OF MPI COMPONENTS

POWER SUPPLY AND IGNITION SWITCH-IG

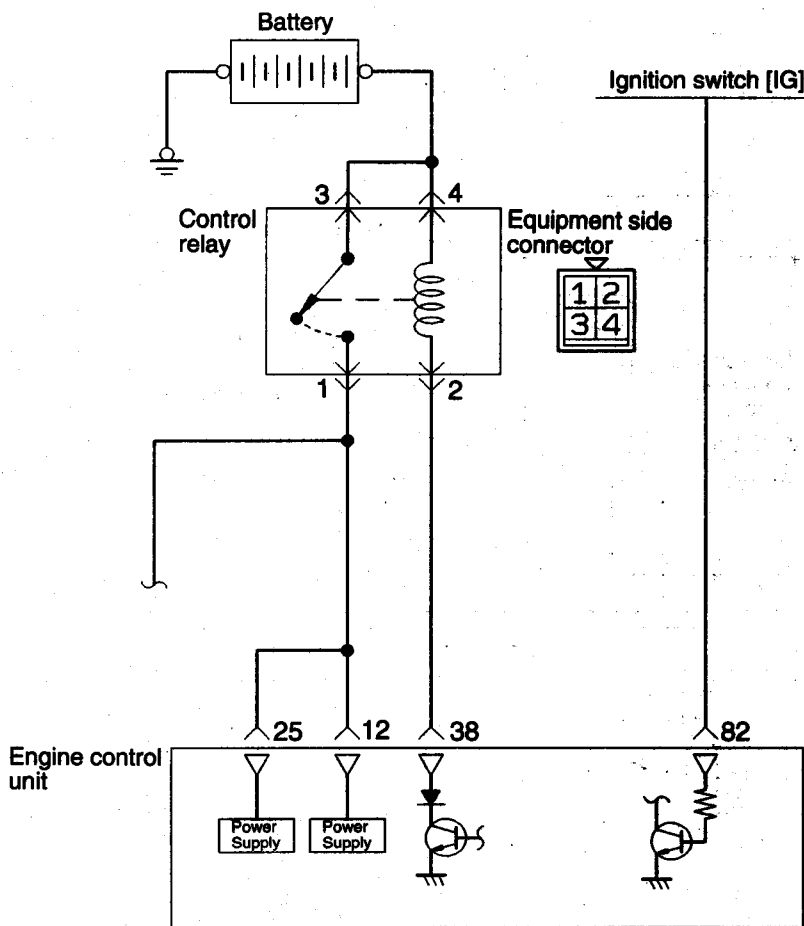
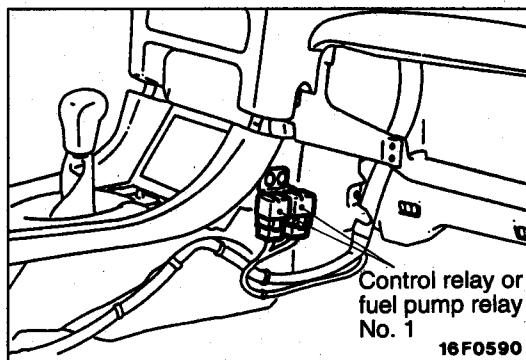
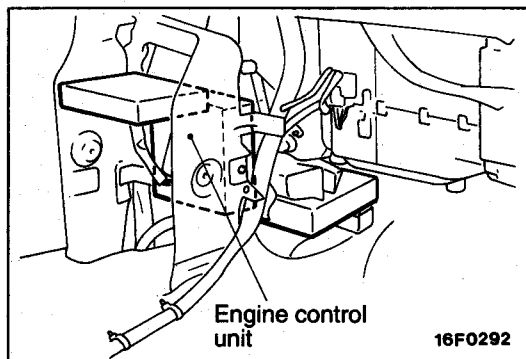

Engine control unit connector

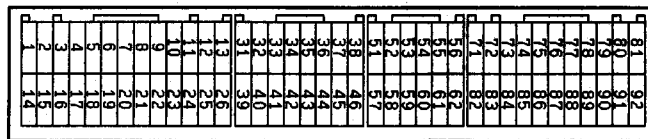

9FU0393

HARNESS INSPECTION

1

Engine control unit harness side connector
01L0427

Measure the ignition switch (IG) terminal input voltage.

- Engine control unit connector: Disconnected

Ignition switch	Voltage (V)
OFF	0 - 1
ON	SV

OK

→

OK

→

2

Repair the harness. (Ignition switch - 82) or check the ignition switch

2

(A) Harness side connector

7FU1928

Measure the power supply voltage of the control relay.

- Ignition switch: OFF
- Control relay connector: Disconnected

Voltage (V)
SV

OK → **3**

✗ → Repair the harness. (Battery – (A) 3) (Battery – (A) 4)

3

(A) Harness side connector

7FU1944

Check for an open-circuit, or a short-circuit to earth, between the engine control unit and the control relay.

- Engine control unit connector: Disconnected
- Control relay connector: Disconnected

OK → **4**

✗ → Repair the harness. (A) 2 – 38) (A) 1 – 12, 25)

4

(A) Harness side connector

7FU1930

Measure power voltage to the actuator.

- Control relay connector: Connected
- Engine control unit connector: Connected

Engine	Voltage (V)
Cranking	8V or higher
Racing	SV

OK → STOP

✗ → Malfunction of control relay or engine control unit

ENGINE CONTROL UNIT POWER EARTH

E13YDAA

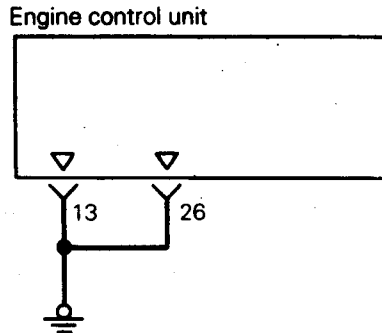
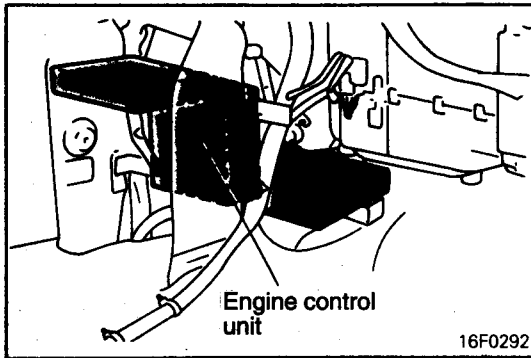

Engine control unit connector

01A0191

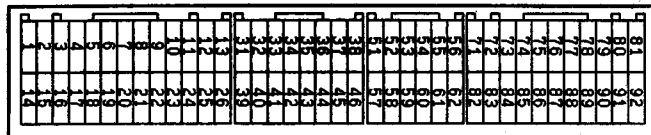

9FU0393

FUEL PUMP

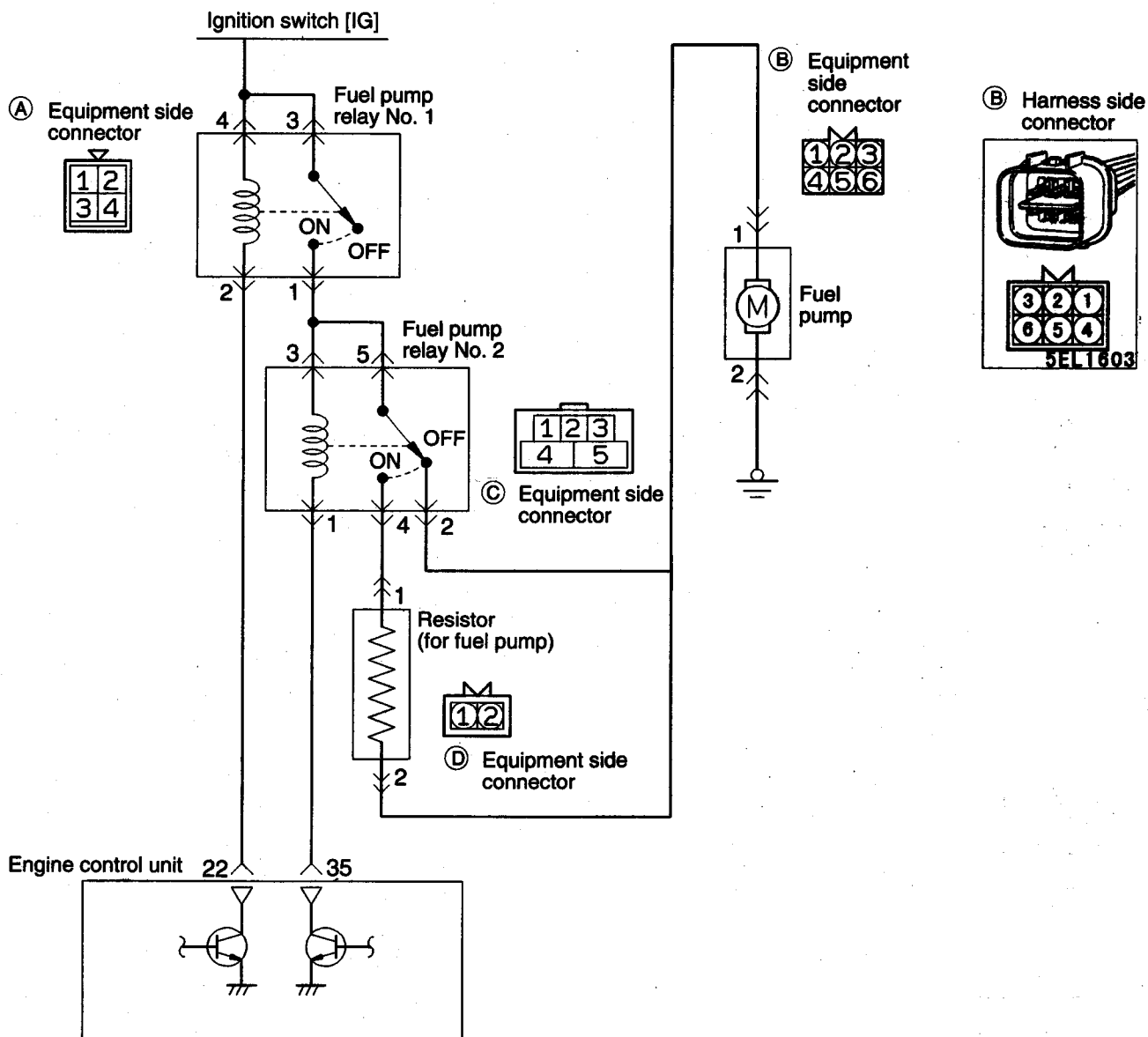

7FU2486

Engine control unit connector

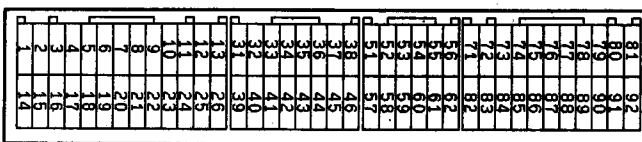

9FU0393

HARNESS INSPECTION

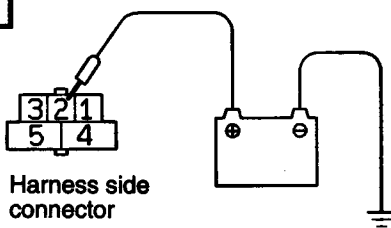
<p>1</p>  <p>© Harness side connector</p> <p style="text-align: right;">7FU2476</p>	<p>Check the fuel pump.</p> <ul style="list-style-type: none"> ● Apply battery voltage to the fuel pump relay No. 2 and operate the pump. 	<p style="text-align: center;">OK → 4</p> <p style="text-align: center;">OK → 2</p>
--	--	--

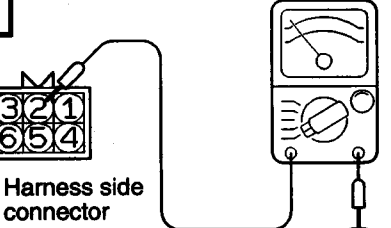
<p>2</p>  <p>Ⓑ Harness side connector</p> <p style="text-align: right;">7FU0954</p>	<p>Check the earth circuit of the fuel pump.</p> <ul style="list-style-type: none"> ● Fuel pump connector: Disconnected 	<p style="text-align: center;">OK → 3</p> <p style="text-align: center;">OK → Repair the harness. (Ⓑ 2) – Earth)</p>
--	--	--

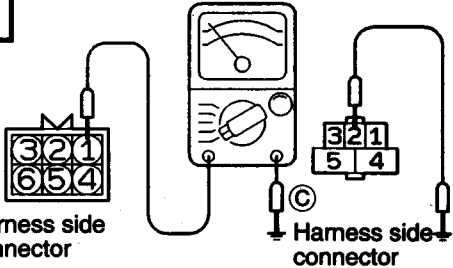
<p>3</p>  <p>Ⓑ Harness side connector</p> <p>© Harness side connector</p> <p style="text-align: right;">7FU0964</p>	<p>Check for an open-circuit, or a short-circuit to earth, between the fuel pump relay No.2 and the fuel pump.</p> <ul style="list-style-type: none"> ● Fuel pump relay No.2 connector: Disconnected ● Fuel pump connector: Disconnected 	<p style="text-align: center;">OK → 4</p> <p style="text-align: center;">OK → Repair the harness. (Ⓑ 1) – © 2)</p>
---	--	--

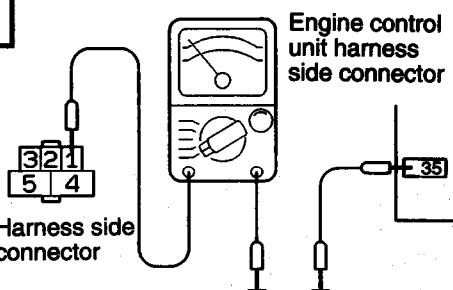
<p>4</p>  <p>© Harness side connector</p> <p>Engine control unit harness side connector</p> <p style="text-align: right;">7FU0961</p>	<p>Check for an open-circuit, or a short-circuit to earth, between the fuel pump relay No.2 and the engine control unit.</p> <ul style="list-style-type: none"> ● Fuel pump relay No.2 connector: Disconnected ● Engine control unit connector: Disconnected 	<p style="text-align: center;">OK → 5</p> <p style="text-align: center;">OK → Repair the harness. (© 1) – (35)</p>
--	--	--

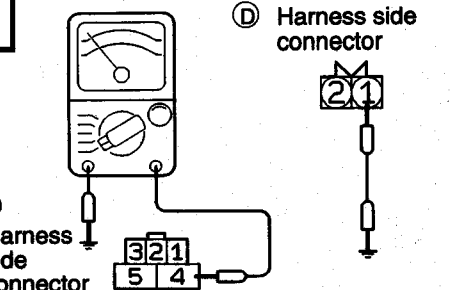
<p>5</p>  <p>© Harness side connector</p> <p>Ⓓ Harness side connector</p> <p style="text-align: right;">7FU0962</p>	<p>Check for continuity between the fuel pump relay No.2 and the resistor (for fuel pump).</p> <ul style="list-style-type: none"> ● Fuel pump relay No.2 connector: Disconnected ● Resistor (for fuel pump) connector: Disconnected 	<p style="text-align: center;">OK → 6</p> <p style="text-align: center;">OK → Repair the harness. (© 4) – Ⓓ 1)</p>
--	---	--

6

B Harness side connector

D Harness side connector

7FU2487

Check for continuity between the resistor (for fuel pump) and fuel pump.

- Resistor (for fuel pump) connector: Disconnected
- Fuel pump connector: Disconnected

OK → **7**

OK → Repair the harness.
(**B** 3) - (**D** 2)

7

A Harness side connector

7FU1928

Measure the power supply voltage of the fuel pump relay No.1.

- Fuel pump relay No.1 connector: Disconnected

Ignition switch	Voltage (V)
OFF	0
ON	SV

OK → **8**

OK → Repair the harness. (Ignition switch – **A** 3) 4) or check the ignition switch.

8

A Harness side connector

Engine control unit harness side connector

7FU2057

Check for an open-circuit, or a short-circuit to earth between the fuel pump relay No.1 and the engine control unit.

- Control relay connector: Disconnected
- Engine control unit connector: Disconnected

OK → **9**

OK → Repair the harness. (**A** 2) - 22)

9

A Harness side connector

C Harness side connector

7FU2038

Check for continuity between the control relay No.1 and the control relay No.2.

- Control relay No.1 connector: Disconnected
- Control relay No.2 connector: Disconnected

OK → **STOP**

OK → Repair the harness.
(**A** 1) - (**C** 3)
(**A** 1) - (**C** 5)

AIR FLOW SENSOR

E13YFAA2

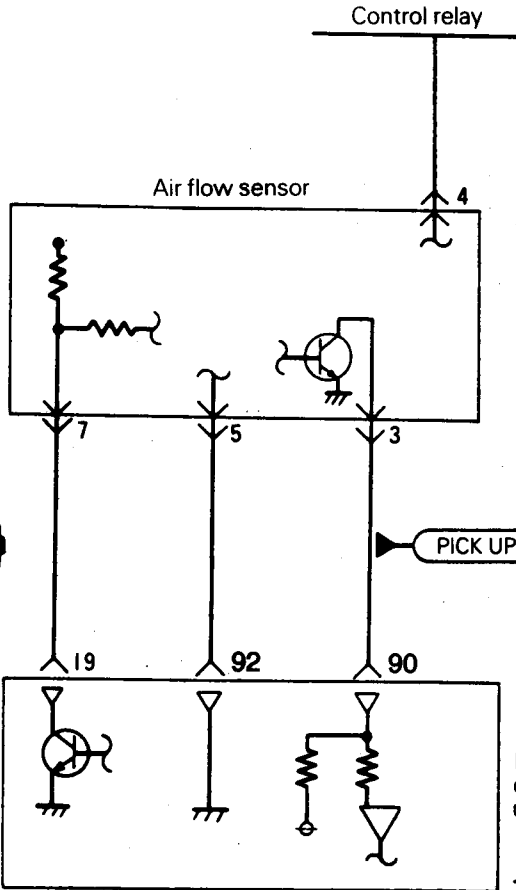
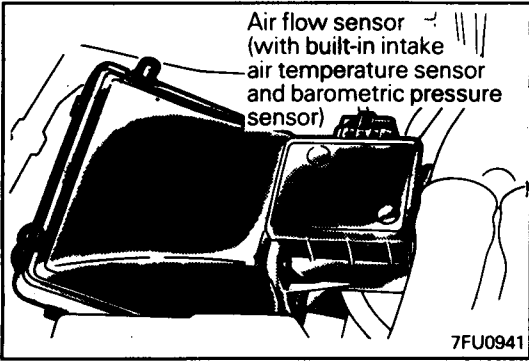

Ⓐ Equipment side connector



Ⓐ Harness side connector

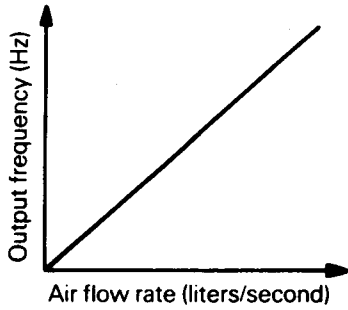
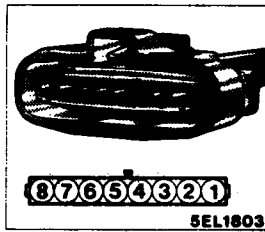

Engine control unit connector

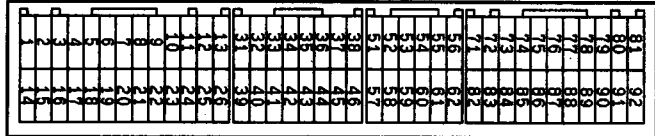

HARNES INSPECTION

<p>1</p> <p>Ⓐ Harness side connector</p> <p style="text-align: right;">7FU0655</p>	<p>Measure the power supply voltage.</p> <ul style="list-style-type: none"> • Connector: Disconnected • Ignition switch: ON <table border="1" style="width: 100%;"> <tr> <td style="text-align: center;">Voltage (V)</td> </tr> <tr> <td style="text-align: center;">SV</td> </tr> </table>	Voltage (V)	SV	<p style="text-align: center;">OK → 2</p> <p style="text-align: center;">OK → Repair the harness (Ⓐ 4 – Control relay) or check the control relay.</p>
Voltage (V)				
SV				

<p>2</p> <p>Ⓐ Harness side connector</p> <p style="text-align: right;">7FU0656</p>	<p>Measure the terminal voltage.</p> <ul style="list-style-type: none"> • Connector: Disconnected • Ignition switch: ON <table border="1" style="width: 100%;"> <tr> <td style="text-align: center;">Voltage (V)</td> </tr> <tr> <td style="text-align: center;">4.8 – 5.2</td> </tr> </table>	Voltage (V)	4.8 – 5.2	<p style="text-align: center;">OK → 3</p> <p style="text-align: center;">OK → Repair the harness. (Ⓐ 3 – 9d)</p>
Voltage (V)				
4.8 – 5.2				

<p>3</p> <p>Ⓐ Harness side connector</p> <p style="text-align: right;">7FU0657</p>	<p>Check for continuity of the earth circuit.</p> <ul style="list-style-type: none"> • Connector: Disconnected 	<p style="text-align: center;">OK → 4</p> <p style="text-align: center;">OK → Repair the harness. (Ⓐ 5 – 9d)</p>
---	---	---

<p>4</p> <p>Ⓐ Harness side connector</p> <p style="text-align: right;">7FU0745</p>	<p>Check for continuity between the air flow sensor and the engine control unit.</p> <ul style="list-style-type: none"> • Air flow sensor connector: Disconnected • Engine control unit connector: Disconnected 	<p style="text-align: center;">OK → STOP</p> <p style="text-align: center;">OK → Repair the harness. (Ⓐ 7 – 19)</p>
---	---	--

INTAKE AIR TEMPERATURE SENSOR

E13YGAA2

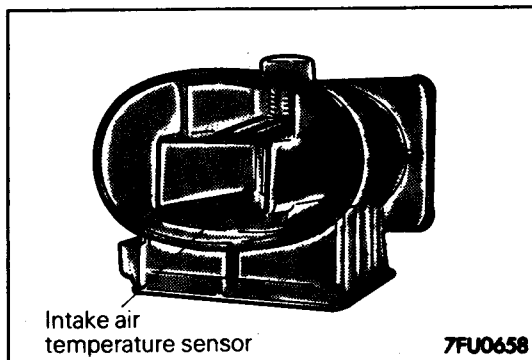
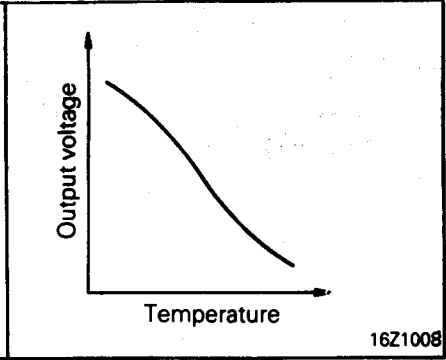
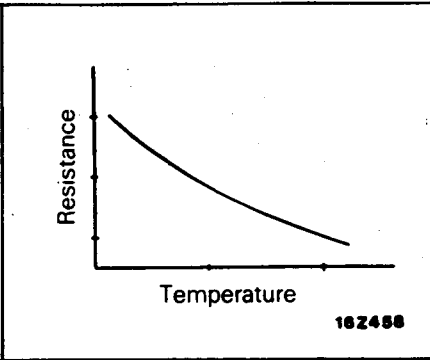
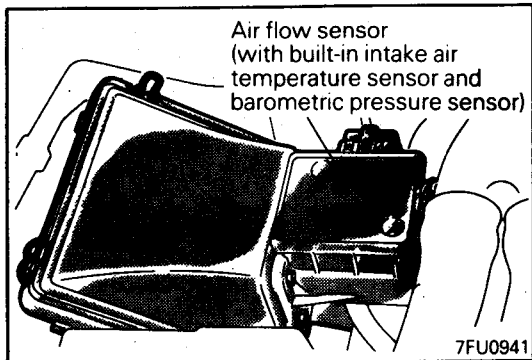

Ⓐ Equipment side connector



Air flow sensor connector

Ⓐ Harness side connector

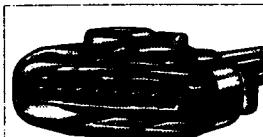

SEL1803

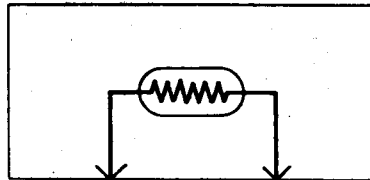

5

6

92

72 Engine control unit

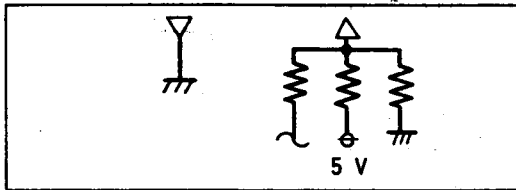

7FU0659

Engine control unit connector

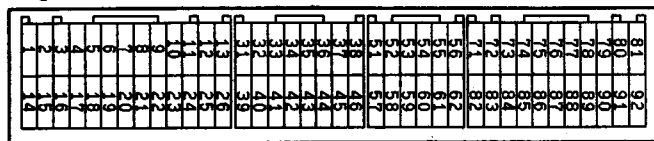

9FU0393

HARNESS INSPECTION

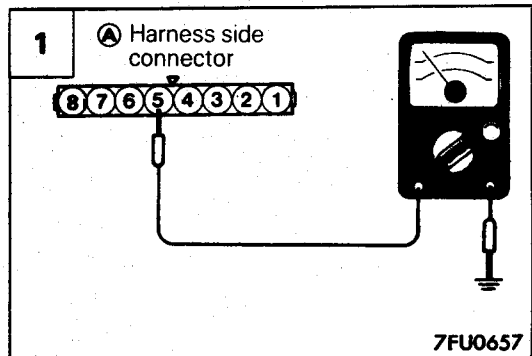

Check for continuity of the earth circuit.

- Connector: Disconnected



2



Repair the harness.
(Ⓐ 5 - 92)

2 (A) Harness side connector

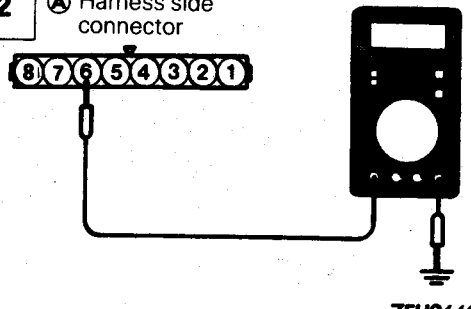

Measure the power supply voltage.

- Connector: Disconnected
- Ignition switch: ON

Voltage (V)
4.5 – 4.9

OK → **STOP**

✗ → **Repair the harness.**
(A) (6) – (72)

7FU0660

BAROMETRIC PRESSURE SENSOR

E13YHAA2

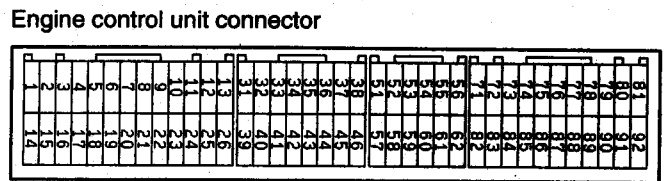
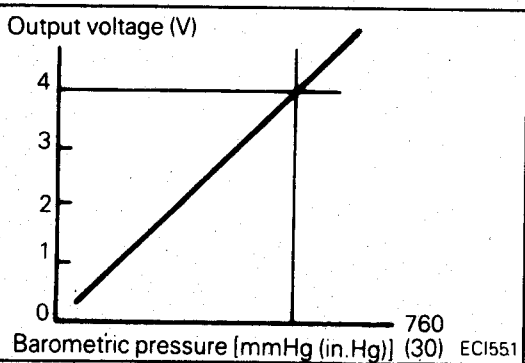
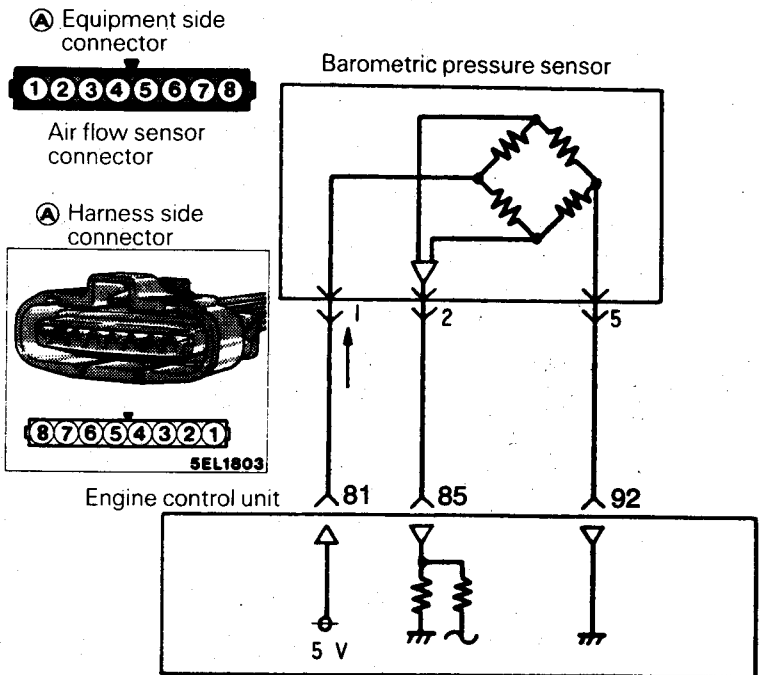
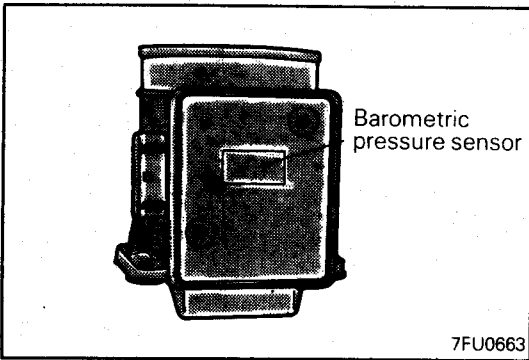
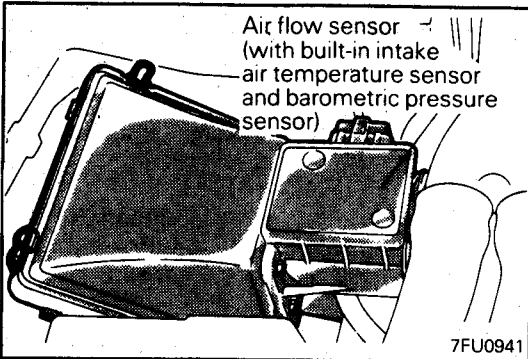

HARNES INSPECTION

1 (A) Harness side connector

7FU0657

Check for continuity of the earth circuit.

- Connector: Disconnected

OK → **2**

~~OK~~ → Repair the harness. (A 5 - 92)

2 (A) Harness side connector

7FU0665

Measure the power supply voltage of the barometric pressure sensor.

- Connector: Disconnected
- Ignition switch: ON

Voltage (V)
4.8 – 5.2

OK → **3**

~~OK~~ → Repair the harness. (A 1 - 81)

3 (A) Harness side connector

7FU0666

Engine control unit harness side connector

Check for an open-circuit, or a short-circuit to earth between the engine control unit and the barometric pressure sensor.

- Air flow sensor connector: Disconnected
- Engine control unit connector: Disconnected

OK → **STOP**

~~OK~~ → Repair the harness. (A 2 - 85)

ENGINE COOLANT TEMPERATURE SENSOR

E13Y1AA2

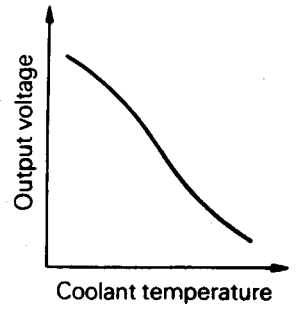
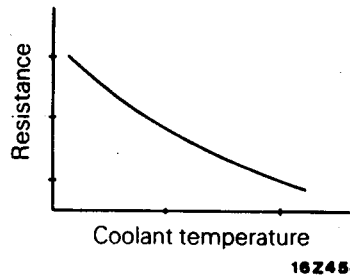
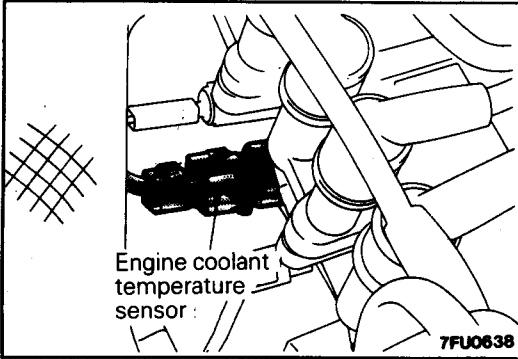

Ⓐ Equipment side Coolant temperature sensor connector

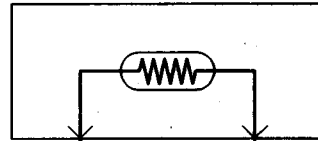

Engine control unit

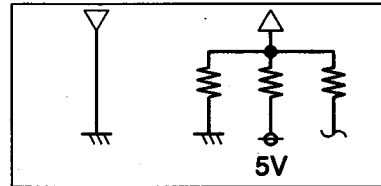

9FU0106

Engine control unit connector

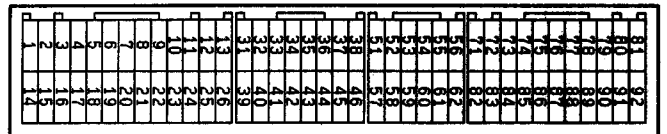

9FU0393

HARNESS INSPECTION

1

Ⓐ Harness side connector

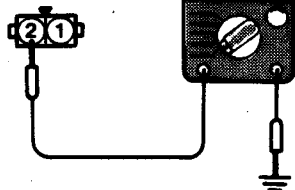

7FU0668

Check for continuity of the earth circuit.

- Connector: Disconnected



2



Repair the harness.
(Ⓐ 2 - 92)

2

Ⓐ Harness side connector

7FU0669

Measure the power supply voltage.

- Connector: Disconnected
- Ignition switch: ON

Voltage (V)
4.5 – 4.9

OK →

✖ → **Repair the harness.**
(Ⓐ 1 – 83)

THROTTLE POSITION SENSOR

E13YJAC

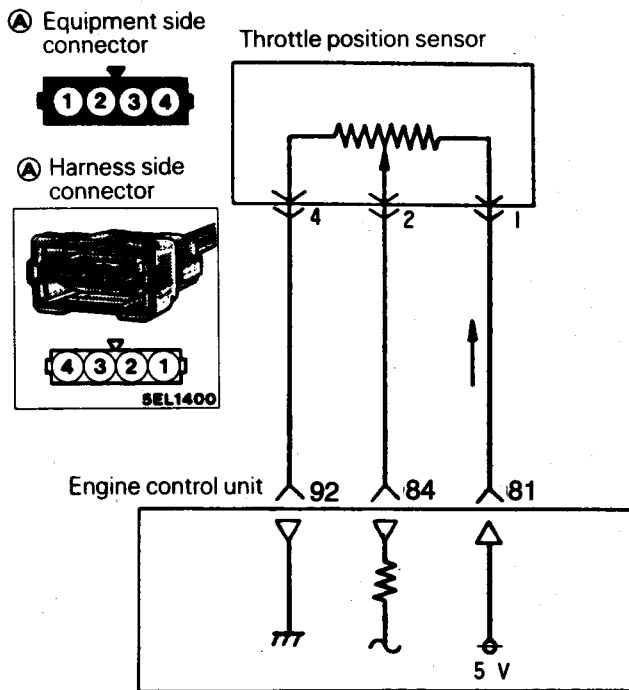
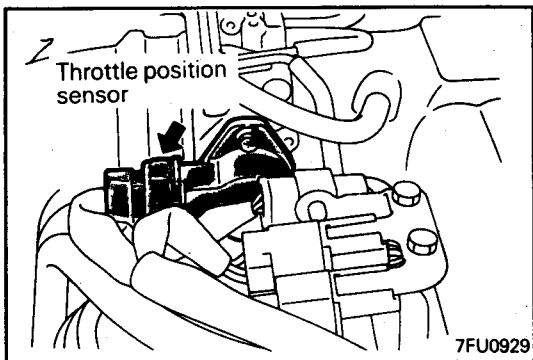

7FU0672

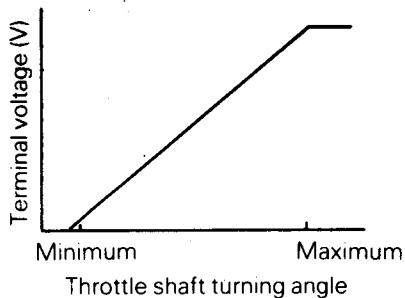



16Z461

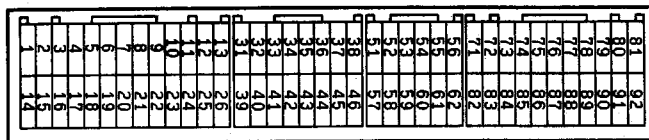

Engine control unit connector



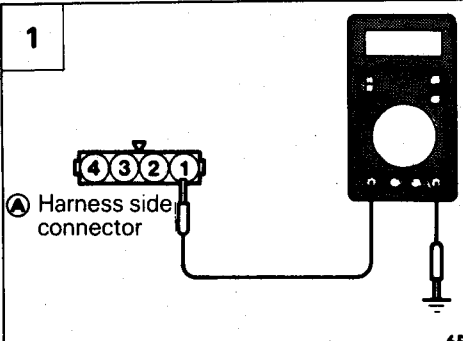

9FU0393

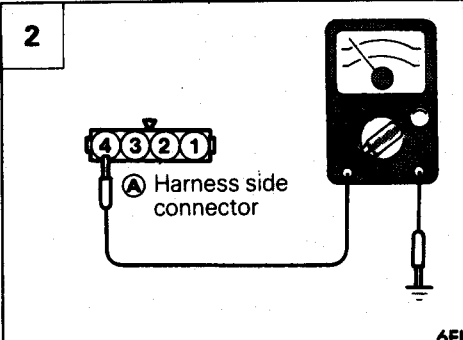
HARNESSES INSPECTION

<p>1</p>	 <p style="text-align: right;">6FUI241</p>	<p>Measure the power supply voltage of the throttle position sensor.</p> <ul style="list-style-type: none"> • Connector: Disconnected • Ignition switch: ON <table border="1" style="margin-left: auto; margin-right: auto;"> <tr> <td style="text-align: center;">Voltage (V)</td> </tr> <tr> <td style="text-align: center;">4.8 – 5.2</td> </tr> </table>	Voltage (V)	4.8 – 5.2	<div style="display: flex; flex-direction: column; align-items: center;"> <div style="margin-bottom: 20px;">  → </div> <div style="margin-bottom: 20px;">  → </div> </div>	<div style="border: 1px solid black; width: 40px; height: 40px; margin: 0 auto; display: flex; align-items: center; justify-content: center; font-size: 2em; font-weight: bold;">2</div> <p style="text-align: center; margin-top: 10px;">Repair the harness. (A 1 – 81)</p>
Voltage (V)						
4.8 – 5.2						

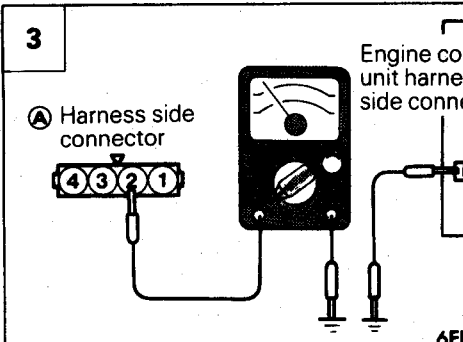
<p>2</p>	 <p style="text-align: right;">6FUI242</p>	<p>Check for continuity of the earth circuit</p> <ul style="list-style-type: none"> • Connector: Disconnected 	<div style="display: flex; flex-direction: column; align-items: center;"> <div style="margin-bottom: 20px;">  → </div> <div style="margin-bottom: 20px;">  → </div> </div>	<div style="border: 1px solid black; width: 40px; height: 40px; margin: 0 auto; display: flex; align-items: center; justify-content: center; font-size: 2em; font-weight: bold;">3</div> <p style="text-align: center; margin-top: 10px;">Repair the harness. (A 4 – 92)</p>
-----------------	---	--	--	--

<p>3</p>	 <p style="text-align: right;">6FUI243</p>	<p>Check for an open circuit, or a short-circuit to earth between the engine control unit and the throttle position sensor.</p> <ul style="list-style-type: none"> • Throttle position sensor connector: Disconnected • Engine control unit connector: Disconnected 	<div style="display: flex; flex-direction: column; align-items: center;"> <div style="margin-bottom: 20px;">  → </div> <div style="margin-bottom: 20px;">  → </div> </div>	<div style="border: 1px solid black; width: 40px; height: 40px; margin: 0 auto; display: flex; align-items: center; justify-content: center; font-size: 2em; font-weight: bold;">STOP</div> <p style="text-align: center; margin-top: 10px;">Repair the harness. (A 2 – 84)</p>
-----------------	--	---	--	---

IDLE POSITION SWITCH

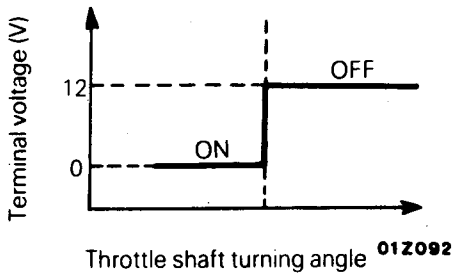
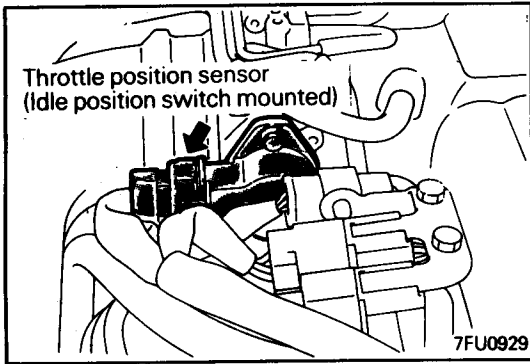

Ⓐ Harness side connector

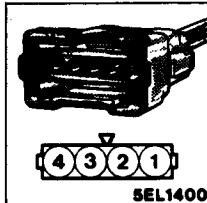

Ⓐ Equipment side connector



Engine control unit

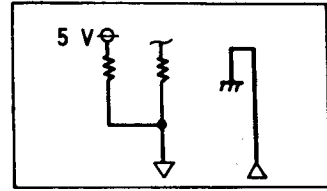

Idle position switch

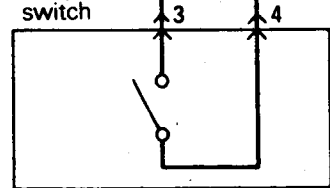

7FU0674

Engine control unit connector

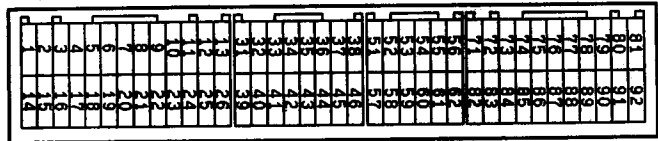

9FU0393

HARNESS INSPECTION

1 Ⓐ Harness side connector

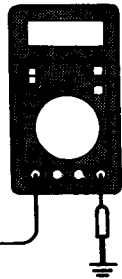

7FU0675

Measure the power supply voltage of the idle position switch.

- Connector: Disconnected
- Ignition switch: ON

Voltage (V)
4 or more



2



Repair the harness.
(Ⓐ 3 - 87)

2



Ⓐ Harness side connector

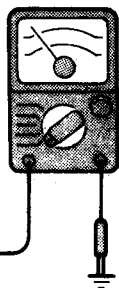

6FU1242

Check for continuity of the earth circuit.

- Connector: Disconnected



Repair the harness.
(Ⓐ 4 - 92)

CAM POSITION SENSOR

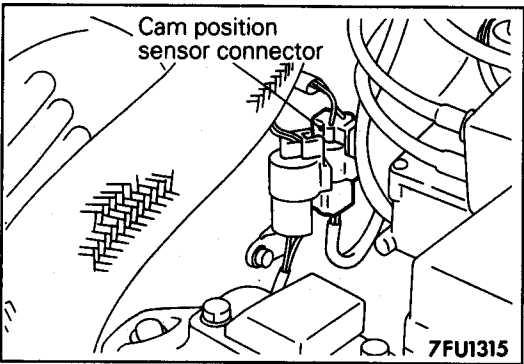
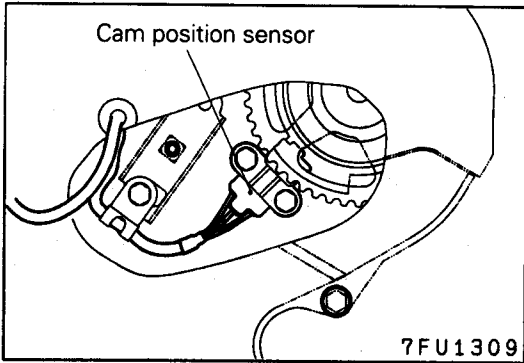

Ⓐ Equipment side connector

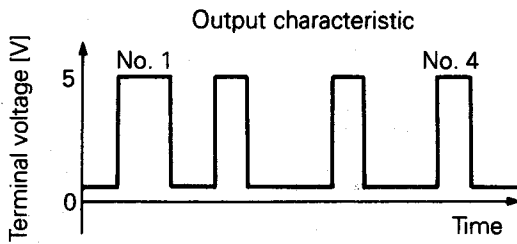
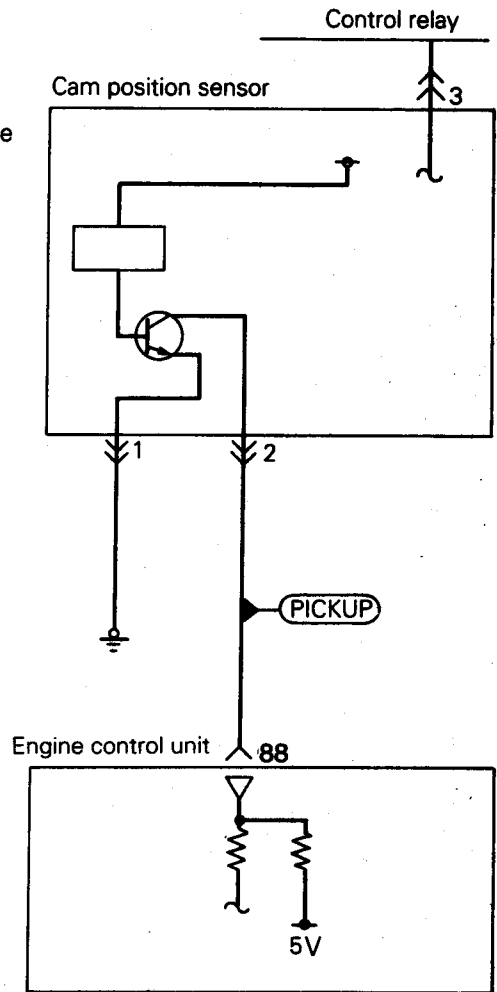

7FU0677

Engine control unit connector

1	2	3	4	5	6	7	8	9	10	11	12	13	14	15	16	17	18	19	20	21	22	23	24	25	26	27	28	29	30	31	32	33	34	35	36	37	38	39	40	41	42	43	44	45	46	47	48	49	50	51	52	53	54	55	56	57	58	59	60	61	62	63	64	65	66	67	68	69	70	71	72	73	74	75	76	77	78	79	80	81	82	83	84	85	86	87	88	89	90	91	92	93	94	95	96	97	98	99	100
---	---	---	---	---	---	---	---	---	----	----	----	----	----	----	----	----	----	----	----	----	----	----	----	----	----	----	----	----	----	----	----	----	----	----	----	----	----	----	----	----	----	----	----	----	----	----	----	----	----	----	----	----	----	----	----	----	----	----	----	----	----	----	----	----	----	----	----	----	----	----	----	----	----	----	----	----	----	----	----	----	----	----	----	----	----	----	----	----	----	----	----	----	----	----	----	----	----	----	-----

9FU0393

6AF0054

HARNESS INSPECTION

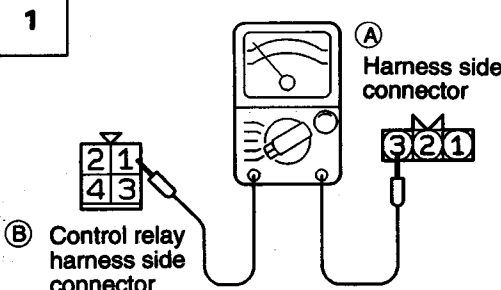
1	 <p style="font-size: small;">(B) Control relay harness side connector</p> <p style="font-size: small;">(A) Harness side connector</p> <p style="text-align: right; font-size: small;">7FU1947</p>	<p>Check for continuity between the cam position sensor and control relay.</p> <ul style="list-style-type: none"> ● Cam position sensor connector :Disconnected ● Control relay connector: Disconnected <p>NOTE Touch ohmmeter probes to both ends of the harness.</p>	<p>OK → 2</p> <p>✖ → Repair the harness. (A 3 - B 1)</p>
----------	--	--	---

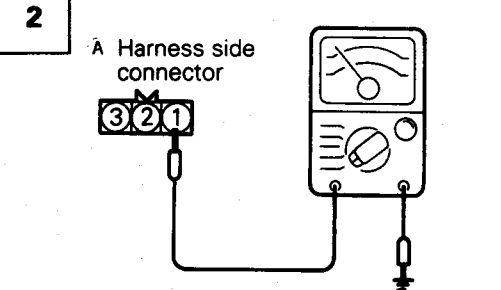
2	 <p style="font-size: small;">A Harness side connector</p> <p style="text-align: right; font-size: small;">6AF0057</p>	<p>Check for continuity of the earth circuit.</p> <ul style="list-style-type: none"> ● Cam position sensor connector: Disconnected 	<p>OK → 3</p> <p>✖ → Repair the harness. (A 1 - Earth)</p>
----------	--	---	---

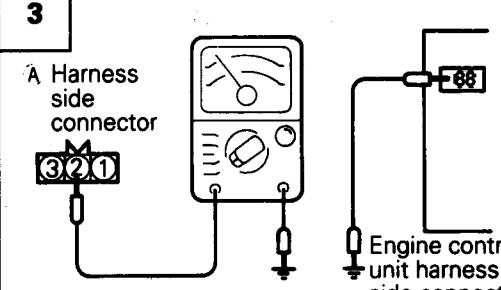
3	 <p style="font-size: small;">A Harness side connector</p> <p style="font-size: small;">Engine control unit harness side connector</p> <p style="text-align: right; font-size: small;">6AF0058</p>	<p>Check for an open-circuit, or a short-circuit to earth between the cam position sensor and the engine control unit.</p> <ul style="list-style-type: none"> ● Engine control unit connector: Disconnected ● Cam position sensor connector: Disconnected 	<p>OK → 4</p> <p>✖ → Repair the harness. (A 2 - B 8)</p>
----------	---	---	---

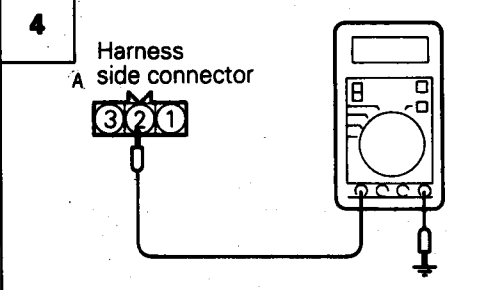
4	 <p style="font-size: small;">A Harness side connector</p> <p style="text-align: right; font-size: small;">6AF0059</p>	<p>Measure the impressed voltage</p> <ul style="list-style-type: none"> ● Cam position sensor connector: Disconnected ● Engine control unit connector: Connected ● Ignition switch: ON <table border="1" style="width: 100%; margin-top: 10px;"> <tr> <td style="text-align: center;">Voltage (V)</td> </tr> <tr> <td style="text-align: center;">4.8 - 5.2</td> </tr> </table>	Voltage (V)	4.8 - 5.2	<p>OK → STOP</p> <p>✖ → Replace the engine control unit.</p>
Voltage (V)					
4.8 - 5.2					

CRANK ANGLE SENSOR

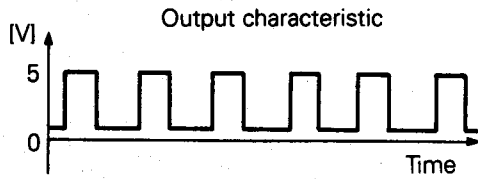
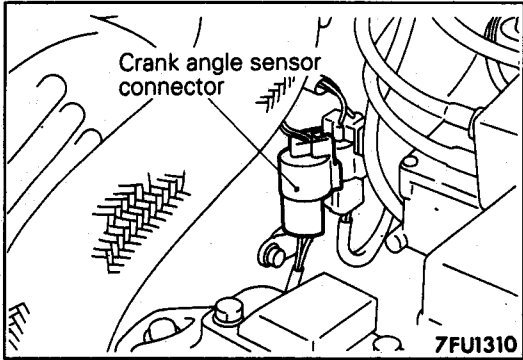
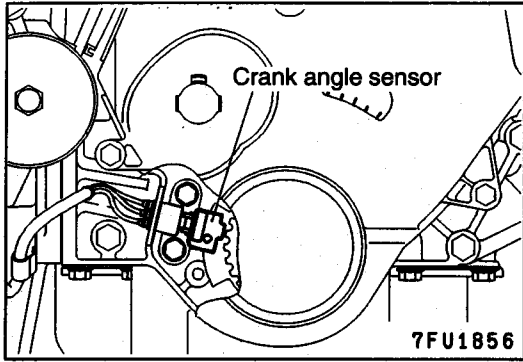

7FU0682

Ⓐ Equipment side connector

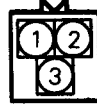

Ⓐ Harness side connector

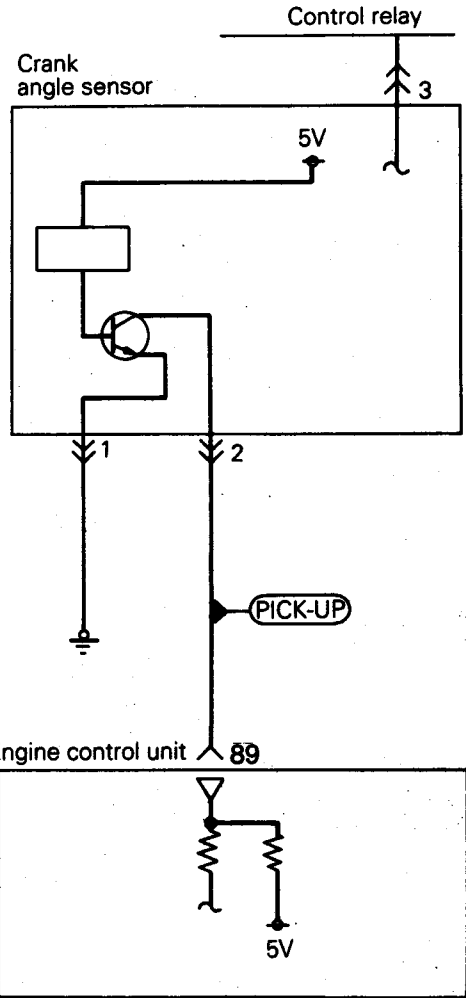
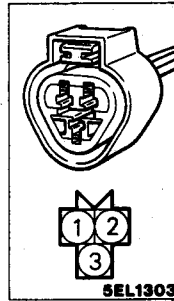

6AF0060

Engine control unit connector

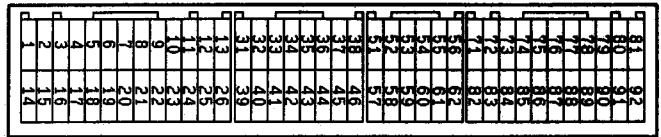

9FU0393

HARNESS INSPECTION

1

Harness side connector A

Control relay harness side connector B

7FU1948

Check for continuity between the crank angle sensor and the control relay.

- Crank angle sensor connector: Disconnected
- Control relay connector: Disconnected

NOTE
Touch ohmmeter probes to both ends of the harness

OK → **2**

~~OK~~ → Repair the harness. (A 1-B 3)

2

Harness side connector A

6AF0062

Check for continuity of the earth circuit.

- Crank angle sensor connector: Disconnected

OK → **3**

~~OK~~ → Repair the harness. (A 1-Earth)

3

Harness side connector A

Engine control unit harness side connector B9

6AF0063

Check for an open-circuit, or a short-circuit to earth between the crank angle sensor and the engine control unit.

- Engine control unit connector: Disconnected
- Crank angle sensor connector: Disconnected

OK → **4**

~~OK~~ → Repair the harness. (A 2 - B9)

4

Harness side connector A

6AF0064

Measure the impressed voltage.

- Crank angle sensor connector: Disconnected
- Engine control unit connector: Connected
- Ignition switch: ON

Voltage (V)
4.8-5.2

OK → STOP

~~OK~~ → Replace the engine control unit.

IGNITION SWITCH-ST

E13YNAA

Engine control unit connector

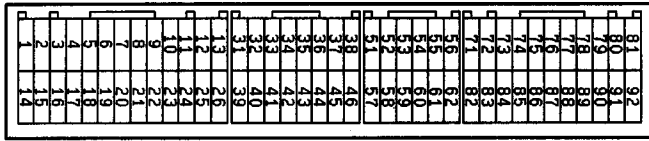

9FU0393

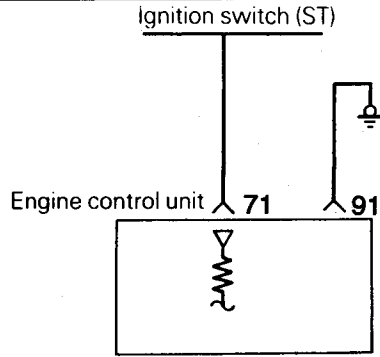

1FU0638

HARNESS INSPECTION

1	<p>Engine control unit harness side connector</p> <p>6FU1258</p>	<p>Measure the input voltage to the engine control unit.</p> <ul style="list-style-type: none"> • Engine control unit connector: Disconnected • Ignition switch: START <table border="1" style="margin-left: auto; margin-right: auto;"> <tr> <td style="text-align: center;">Voltage (V)</td> </tr> <tr> <td style="text-align: center;">8 or more</td> </tr> </table>	Voltage (V)	8 or more	<div style="display: flex; align-items: center; justify-content: center;"> <div style="font-size: 2em; margin-right: 10px;">OK</div> <div style="margin-right: 10px;">→</div> <div style="border: 1px solid black; padding: 5px; width: 30px; height: 30px; text-align: center; line-height: 30px;">2</div> </div> <div style="display: flex; align-items: center; justify-content: center; margin-top: 10px;"> <div style="font-size: 2em; margin-right: 10px;">OK</div> <div style="margin-right: 10px;">→</div> <div style="text-align: left;"> <p>Repair the harness. (71 – Ignition switch)</p> </div> </div>
Voltage (V)					
8 or more					

2	<p>Engine control unit harness side connector</p> <p>6FU1259</p>	<p>Check for continuity of the earth circuit.</p> <ul style="list-style-type: none"> • Engine control unit connector: Disconnected 	<div style="display: flex; align-items: center; justify-content: center;"> <div style="font-size: 2em; margin-right: 10px;">OK</div> <div style="margin-right: 10px;">→</div> <div style="border: 1px solid black; padding: 5px; text-align: center;">STOP</div> </div> <div style="display: flex; align-items: center; justify-content: center; margin-top: 10px;"> <div style="font-size: 2em; margin-right: 10px;">OK</div> <div style="margin-right: 10px;">→</div> <div style="text-align: left;"> <p>Repair the harness. (91 – Earth)</p> </div> </div>
----------	--	---	--

VEHICLE SPEED SENSOR

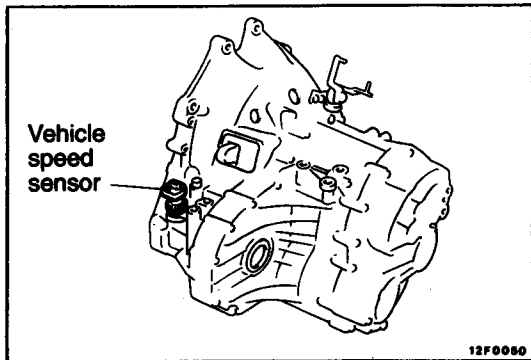

Terminal voltage (V)

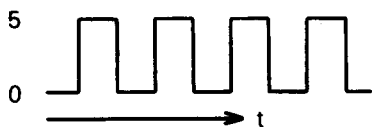

16Z478

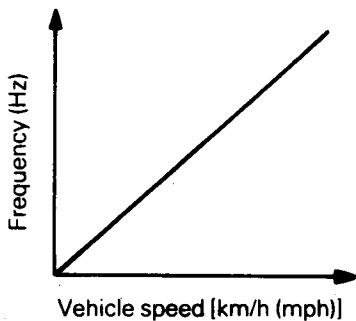

16Z451

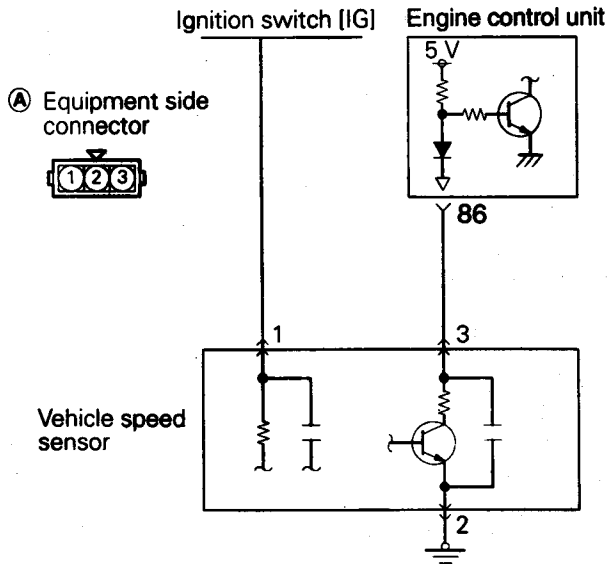

7FU1434

Engine control unit connector

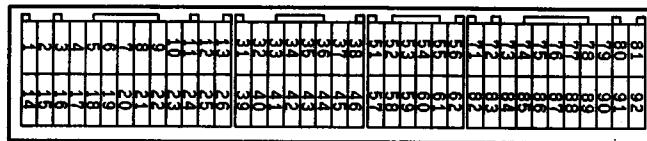

9FU0393

HARNES INSPECTION

1

Ⓐ Harness side connector

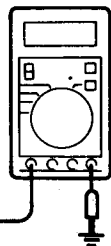

1FU0969

Measure the line voltage of the vehicle speed sensor.

- Connector: Disconnected
- Ignition switch: ON

Voltage (V)
B+



2



Repair the harness.
(Ⓐ 1-Ignition switch)

2

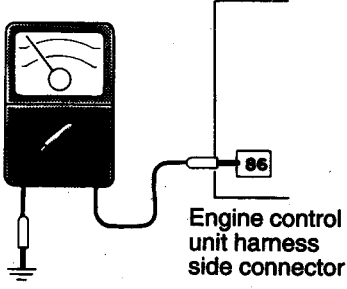

Engine control unit harness side connector

01A0508

Check the vehicle speed sensor output circuit for continuity.

- Engine control unit connector: **Disconnected**
- Ignition switch: ON
- Move the vehicle

Continuity

OK → **STOP**

✗ → **3**

3

(A) Harness side connector

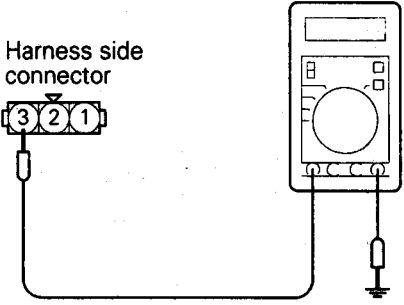

7FU1442

Measure the power supply voltage of the vehicle speed sensor.

- Connector: **Disconnected**
- Ignition switch: ON

Voltage (V)
4.5 – 4.9

OK → **4**

✗ → Repair the harness. (A 3 – 86)

4

(A) Harness side connector

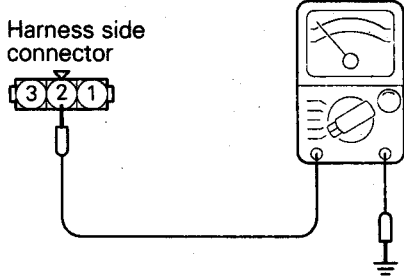

7FU1443

Check for continuity of the ground circuit.

- Connector: **Disconnected**

OK → **STOP**

✗ → Repair the harness. (A 2 – Ground)

POWER STEERING FLUID PRESSURE SWITCH

E13YQAA

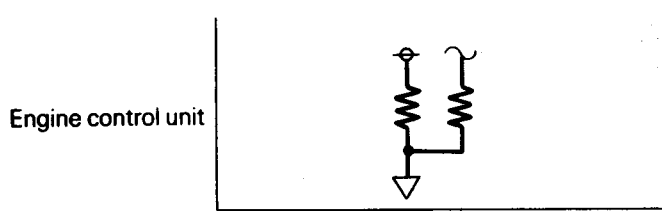
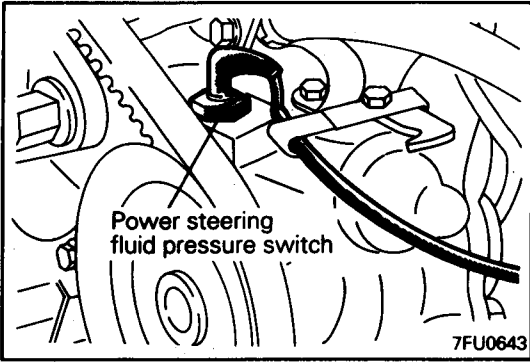

Power steering fluid pressure switch

Ⓐ Harness side connector

1

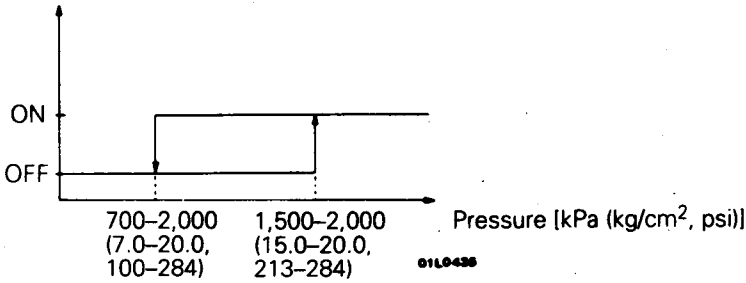

7FU0536

Engine control unit connector

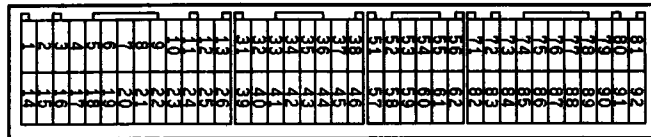

9FU0393

HARNESS INSPECTION

1

Ⓐ Harness side connector

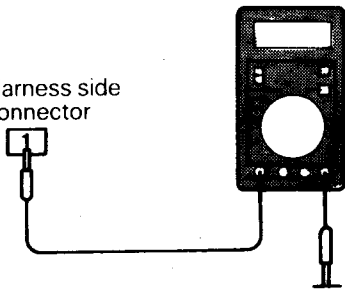

7FU0505

Measure the power supply voltage.

- Connector: Disconnected
- Ignition switch: ON

Voltage (V)
SV

OK

OK

STOP

Repair the harness.
Ⓐ 1 - 37

AIR CONDITIONER SWITCH AND POWER RELAY

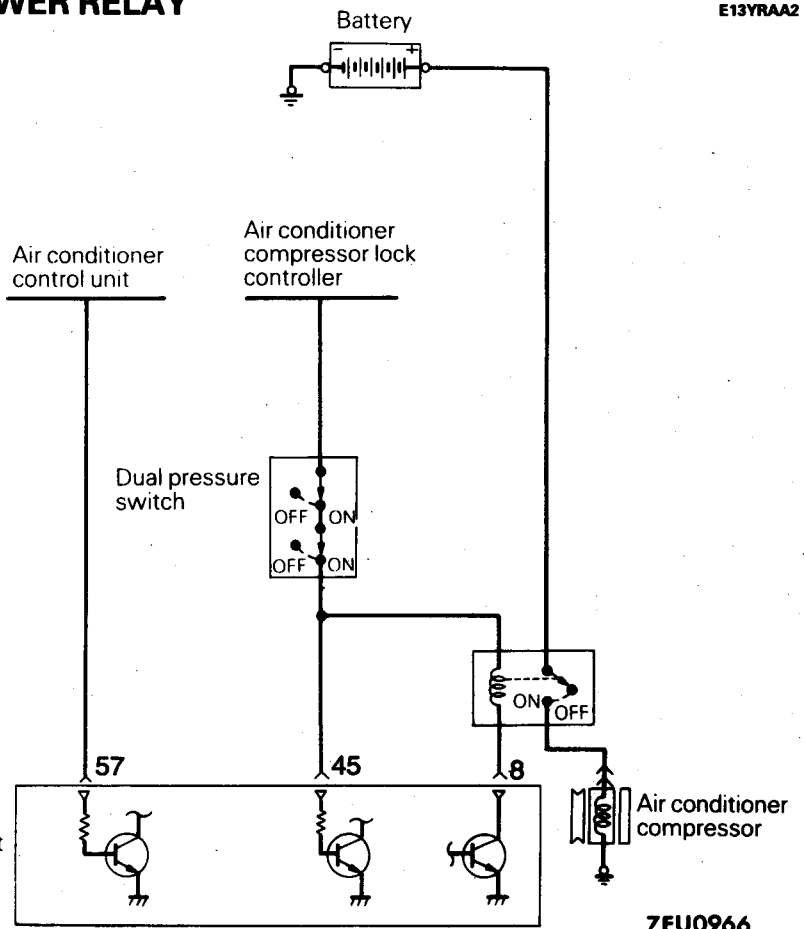
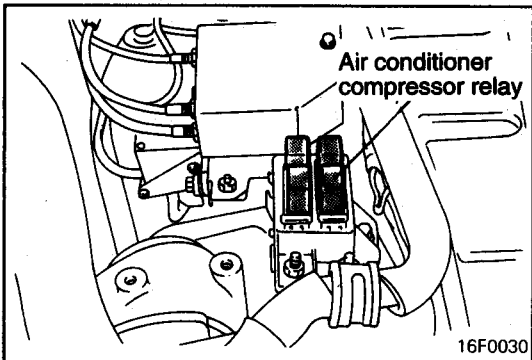
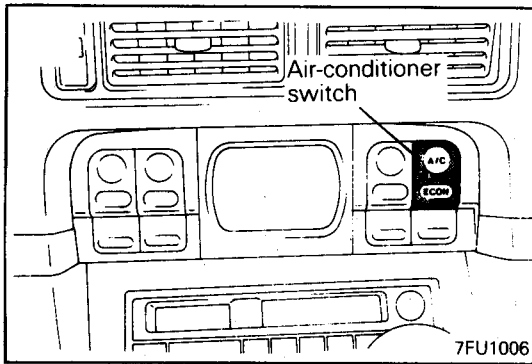

Engine control unit

Engine control unit connector

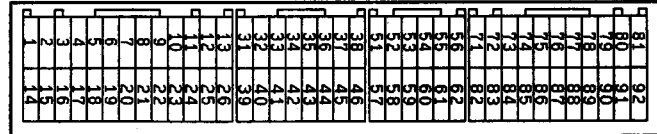

9FU0393

HARNESS INSPECTION

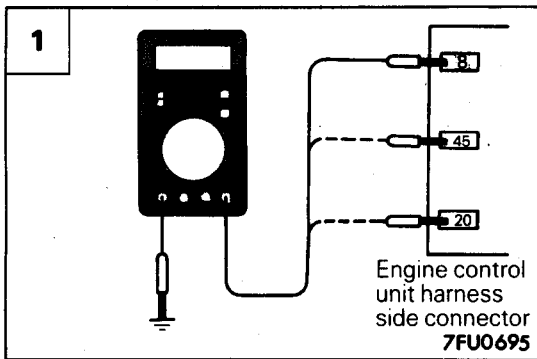

Measure the power supply voltage of the air conditioner circuit.

- Air conditioner switch: ON
- Engine control unit connector: Disconnected
- Ignition switch: ON

Voltage (V)
SV

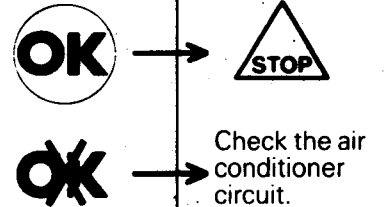

DETONATION SENSOR

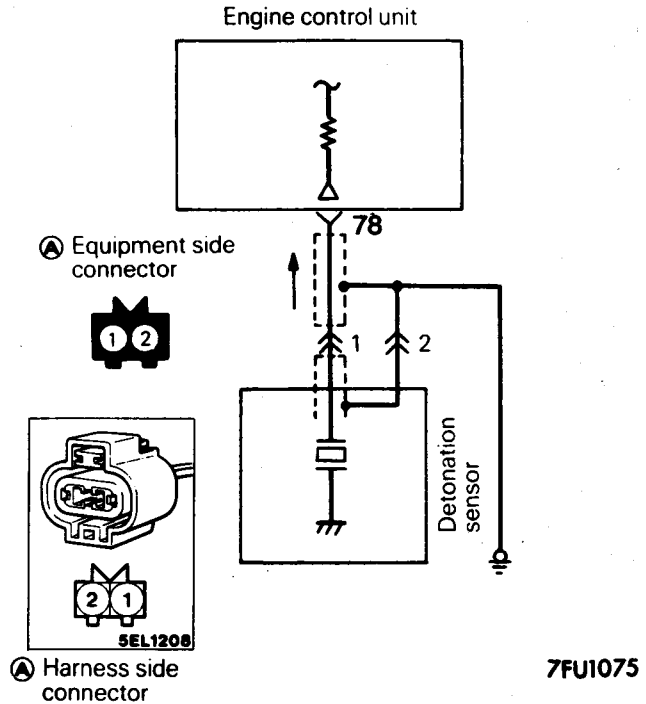
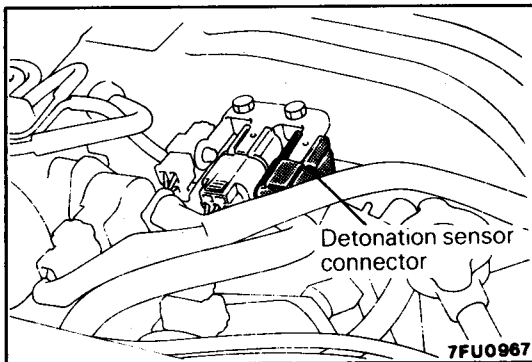
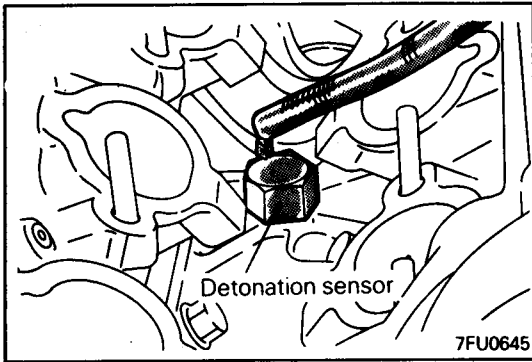

Engine control unit connector

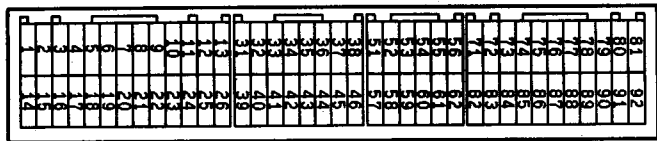

HARNESS INSPECTION

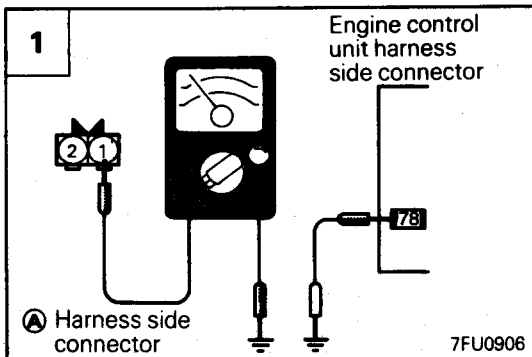

Check for an open-circuit or a short-circuit to earth, between the engine control unit and detonation sensor.

- Detonation sensor connector: Disconnected
- Engine control unit connector: Disconnected



2



Repair the harness.
(A 1 - 78)

2

Ⓐ Harness side connector

6FU1302

Check for continuity of the earth circuit.

- Connector: Disconnected

ELECTRICAL LOAD SWITCH

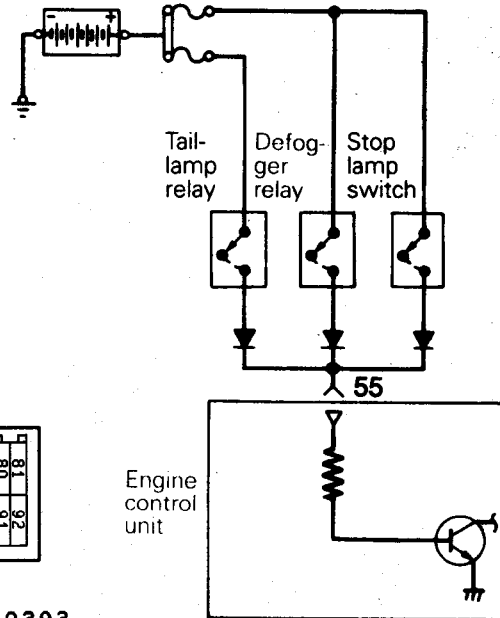
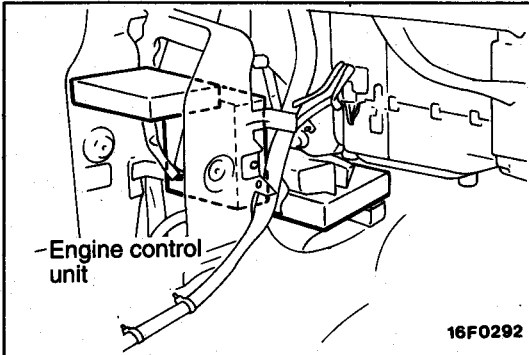

Engine control unit connector

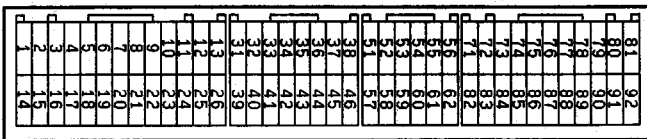

9FU0393

7FU0688

HARNESS INSPECTION

1

Engine control unit harness side connector

7FU0689

Measure the input voltage of engine control unit.

- Engine control unit connector: Disconnected
- Lighting switch: ON (Tail lamp relay ON)

Voltage (V)
SV

2

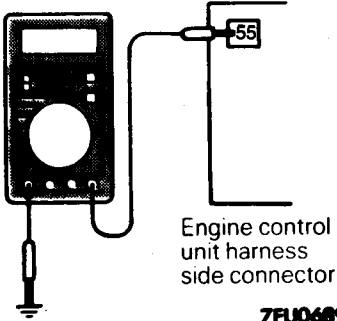

Engine control unit harness side connector

7FU0689

Measure the input voltage of engine control unit.

- Engine control unit connector: Disconnected
- Defogger switch: ON (Defogger relay ON)

Voltage (V)
SV

OK → **3**

OK → Check circuit related to defogger relay

3

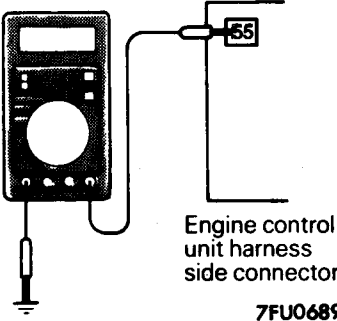

Engine control unit harness side connector

7FU0689

Measure the input voltage of engine control unit.

- Engine control unit connector: Disconnected
- Brake pedal: Depressed (Stop lamp switch ON)

Voltage (V)
SV

OK → **STOP**

OK → Check circuit related to stop lamp relay

OXYGEN SENSOR

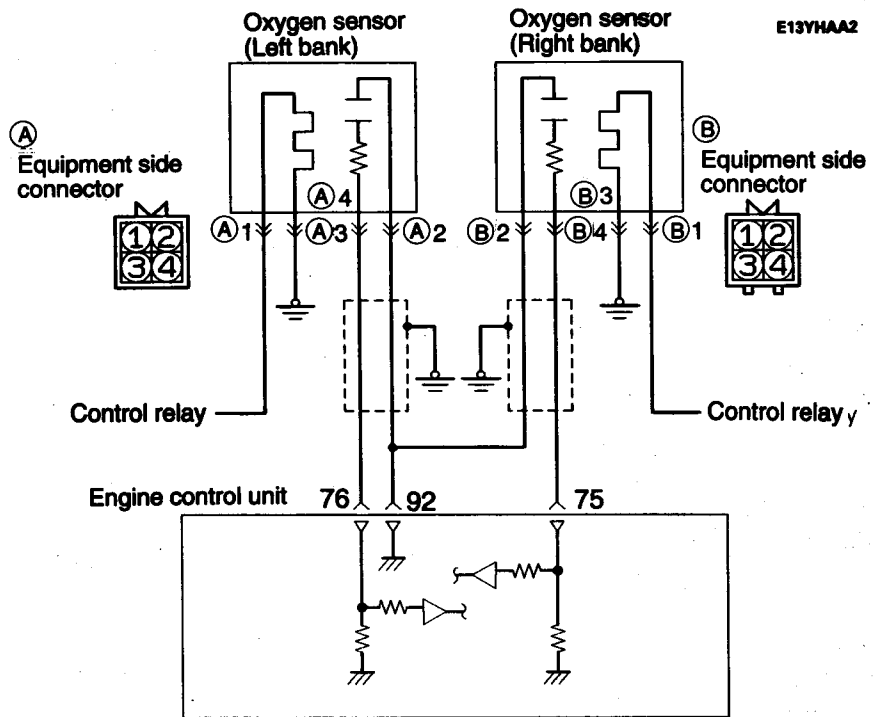
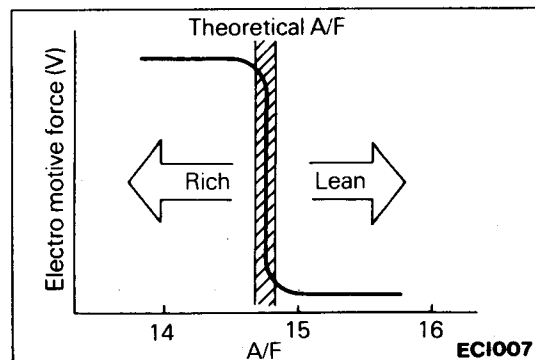
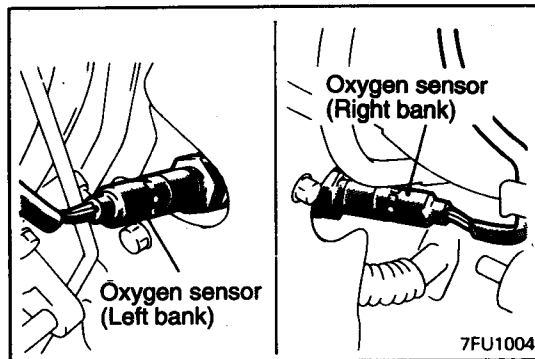

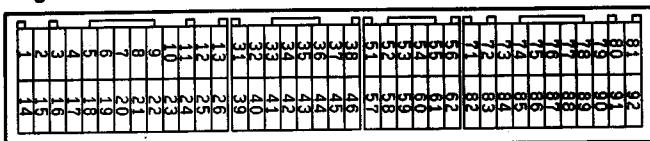

Engine control unit connector

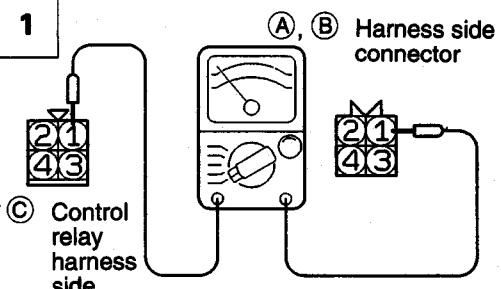

HARNES INSPECTION

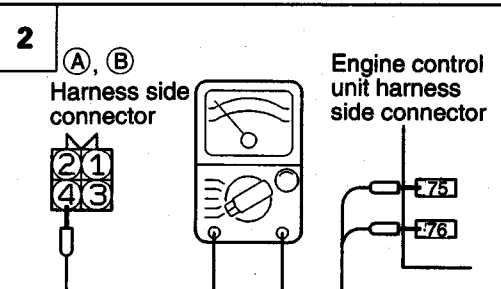
<p>1</p>  <p>(A, B) Harness side connector</p> <p>(C) Control relay harness side connector</p> <p style="text-align: right;">7FU2107</p>	<p>Check for continuity between the oxygen sensor and the control relay.</p> <ul style="list-style-type: none"> • Control relay connector: Disconnected • Oxygen sensor connector: Disconnected <p>NOTE Touch the ohmmeter probes to both ends of the harness.</p>	<p style="text-align: center; font-size: 2em;">OK</p> <p style="text-align: center;">→ 2</p> <p style="text-align: center; font-size: 2em;">OK</p> <p style="text-align: center;">→ Repair the harness.</p> <p style="text-align: center;">(A 1 - C 1, B 1 - C 1)</p>
--	---	--

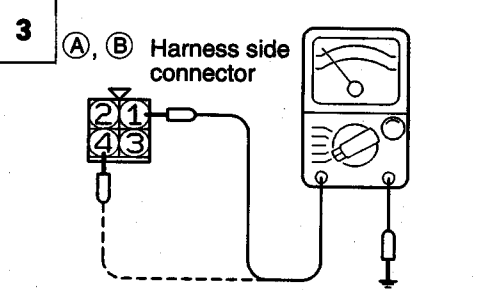
<p>2</p>  <p>(A, B) Harness side connector</p> <p>Engine control unit harness side connector</p> <p style="text-align: right;">7FU2108</p>	<p>Check for an open-circuit, or a short-circuit to earth, between the engine control unit and the oxygen sensor.</p> <ul style="list-style-type: none"> • Oxygen sensor connector: Disconnected • Engine control unit connector: Disconnected 	<p style="text-align: center; font-size: 2em;">OK</p> <p style="text-align: center;">→ 3</p> <p style="text-align: center; font-size: 2em;">OK</p> <p style="text-align: center;">→ Repair the harness.</p> <p style="text-align: center;">(A 4 - 76) (B 4 - 75)</p>
--	--	---

<p>3</p>  <p>(A, B) Harness side connector</p> <p style="text-align: right;">7FU1133</p>	<p>Check for continuity of the earth circuit.</p> <ul style="list-style-type: none"> • Connector: Disconnected 	<p style="text-align: center; font-size: 2em;">OK</p> <p style="text-align: center;">→ </p> <p style="text-align: center; font-size: 2em;">OK</p> <p style="text-align: center;">→ Repair the harness.</p> <p style="text-align: center;">(A 2, B 2 - 92) (A 3, B 3 - Earth)</p>
---	---	--

FAN MOTOR RELAY (RADIATOR FAN, CONDENSER FAN) <From 1995 models>

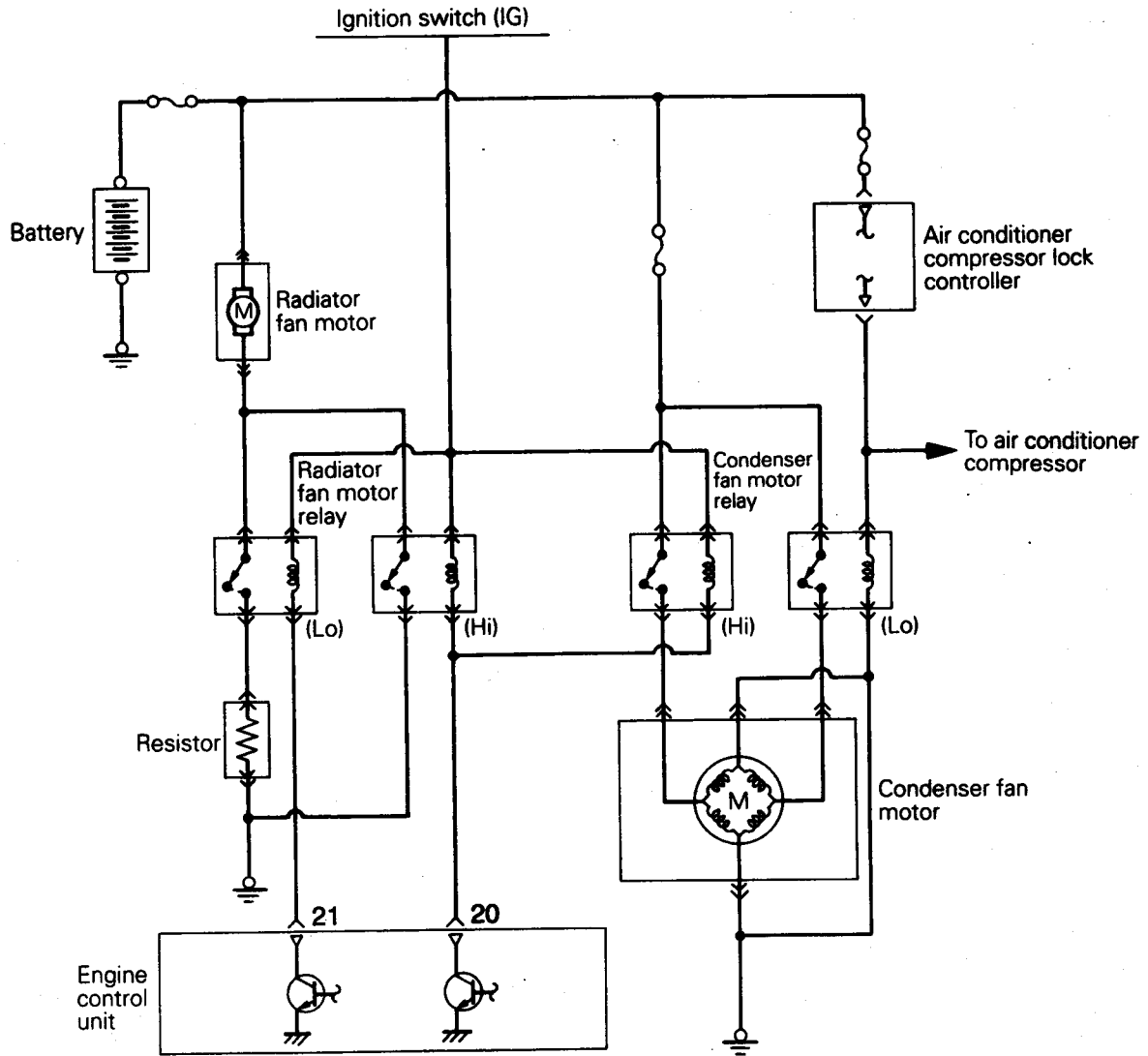
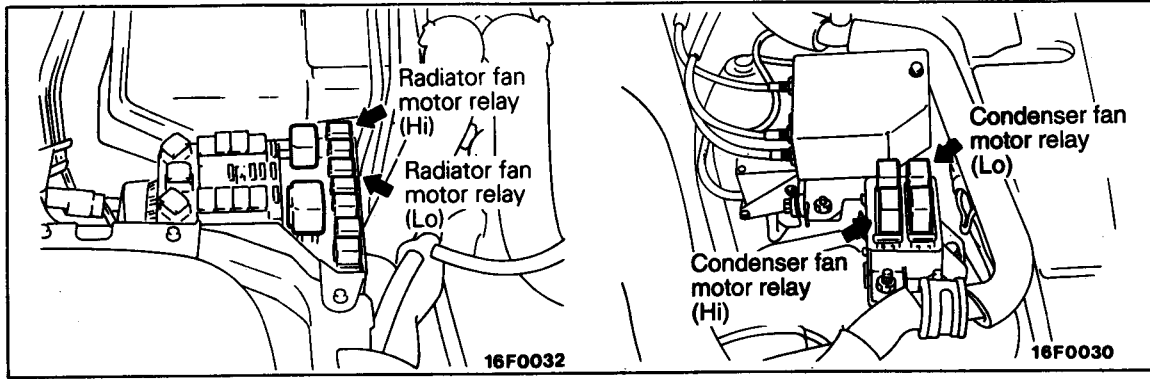

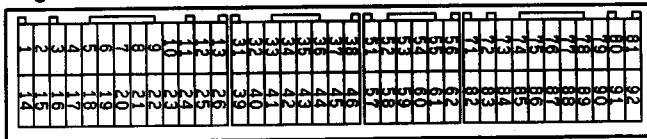

7FU1366

Engine control unit connector

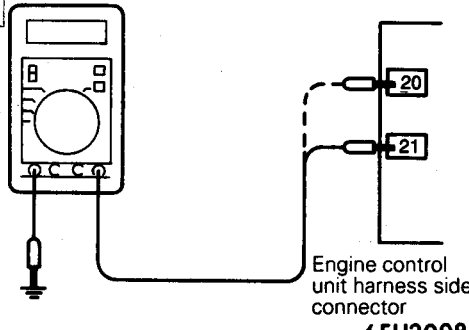

HARNESS INSPECTION

<p>1</p>  <p>Engine control unit harness side connector 6FU2008</p>	<p>Measure input voltage applied to engine control unit</p> <ul style="list-style-type: none"> • Engine control unit connector: Disconnected • Ignition switch: ON <table border="1" data-bbox="674 300 1121 414"> <tr> <td>Voltage (V)</td> </tr> <tr> <td>B+</td> </tr> </table>	Voltage (V)	B+	<p>OK → </p> <p>OK → Check the fan motor relay circuit</p>
Voltage (V)				
B+				

INJECTORS

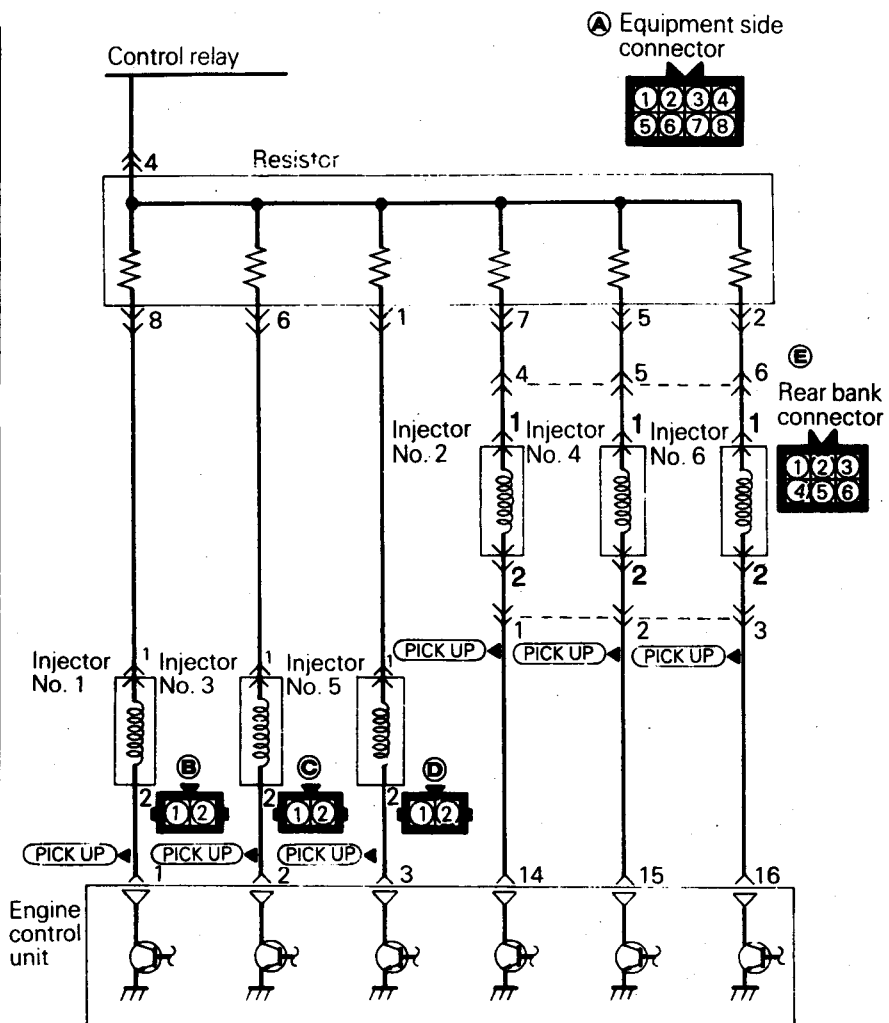
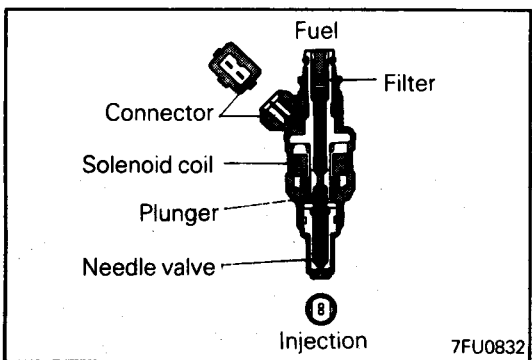
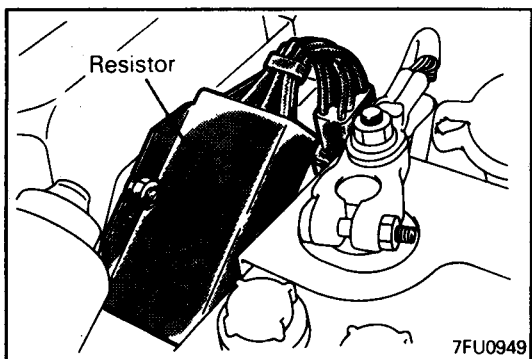
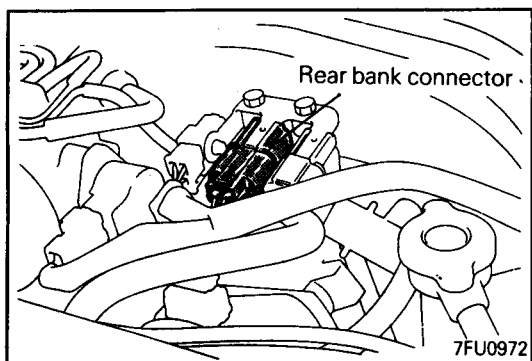
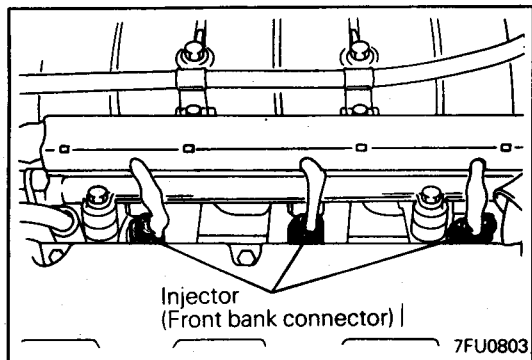

Engine control unit connector

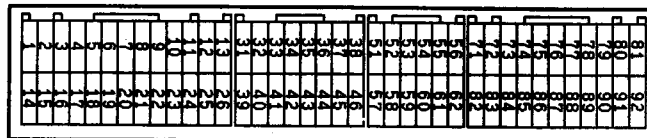

IDLE SPEED CONTROL SERVO (STEPPER MOTOR TYPE)

E13YUAD

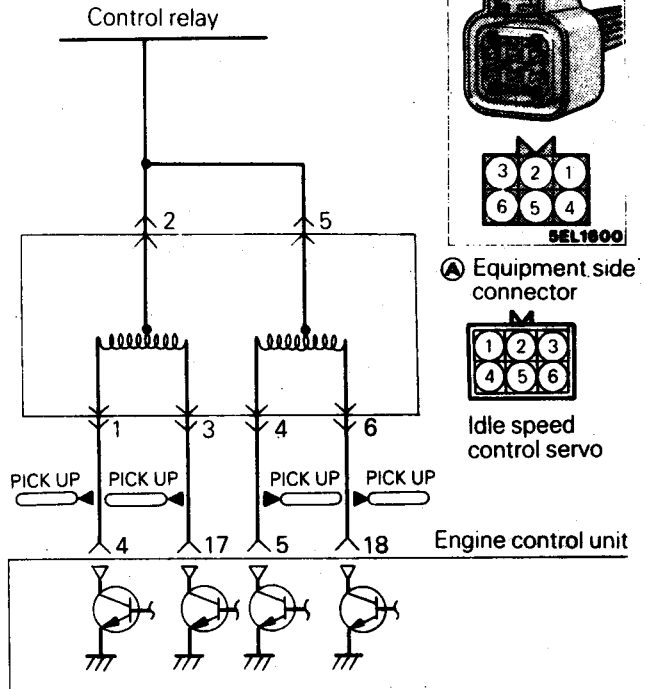
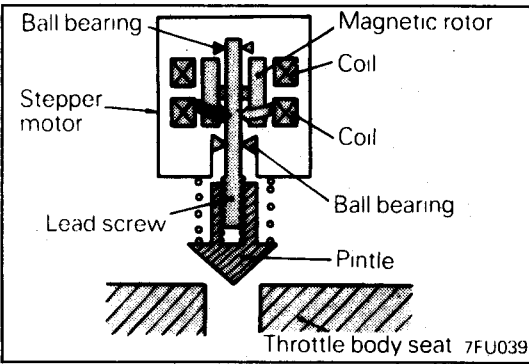
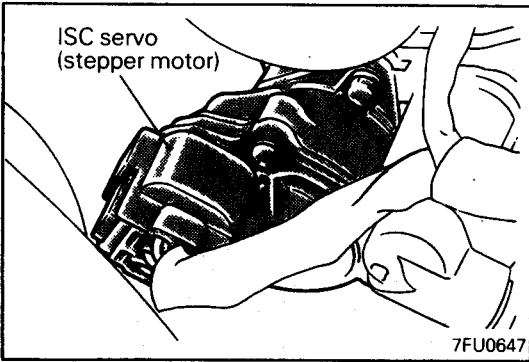

Engine control unit connector

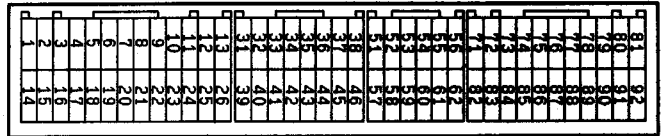

9FU0393

IGNITION COIL AND POWER TRANSISTOR

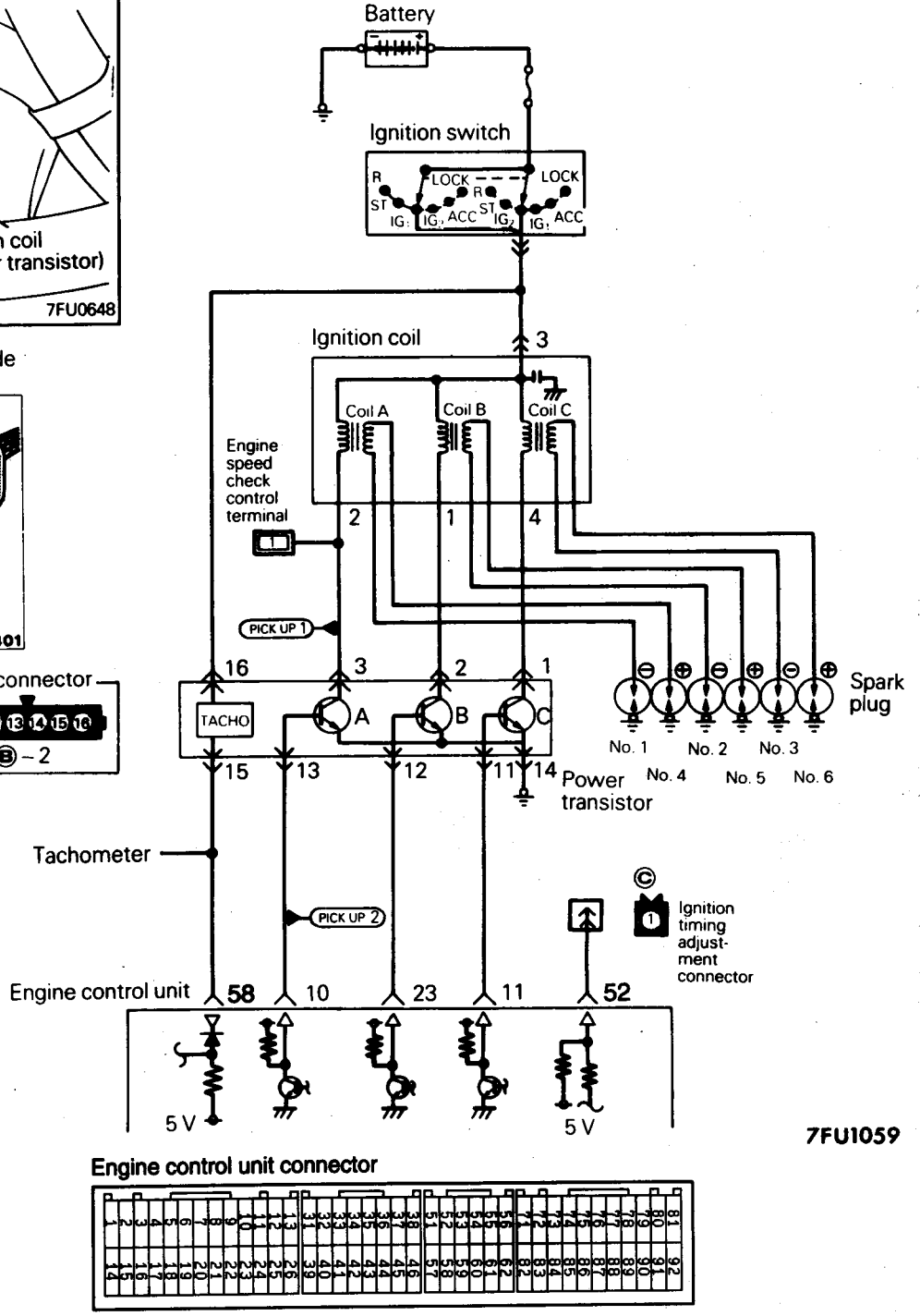
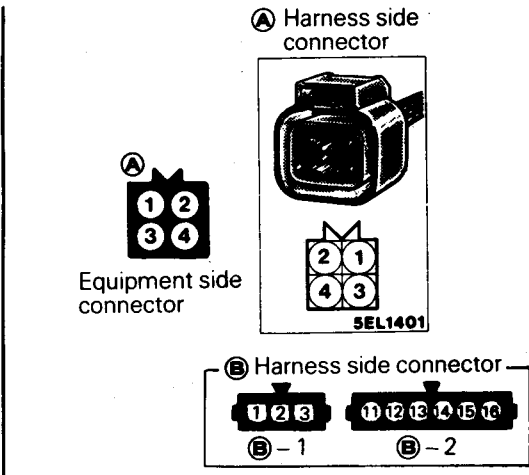
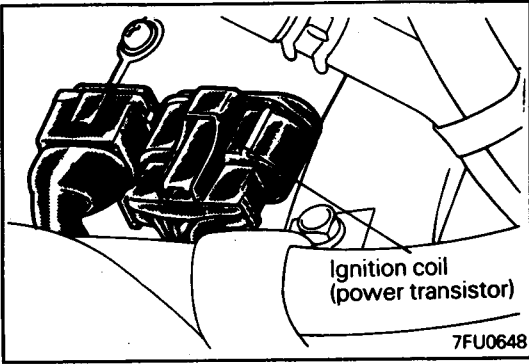

7FU1059

9FU0393

HARNES INSPECTION

1

Ⓐ Harness side connector

01L0477

Measure the power supply voltage of the ignition coil.

- Connector: Disconnected
- Ignition switch: ON

Voltage (V)
SV

OK → **2**

OK → Repair the harness. (Ⓐ 3) – Ignition switch)

2

Ⓑ – 2 Harness side connector

7FU0698

Measure the power supply voltage of the ignition coil.

- Connector: Disconnected
- Ignition switch: ON

Voltage (V)
SV

OK → **3**

OK → Repair the harness. (Ⓑ 14) – Ignition switch)

3

Ⓑ – 2 Harness side connector

6FU1251

Engine control unit harness side connector

Check for an open-circuit, or a short-circuit to earth between the engine control unit and the power transistor.

- Engine control unit connector: Disconnected
- Power transistor connector: Disconnected

OK → **4**

OK → Repair the harness. (Ⓑ 15 – 58)

4

Ⓑ – 1 Harness side connector

7FU0699

Ⓐ Harness side connector

Check for an open-circuit, or a short-circuit to earth between the power transistor and the ignition coil.

- Ignition coil connector: Disconnected
- Power transistor connector: Disconnected

OK → **5**

OK → Repair the harness. (Ⓐ 2 – Ⓑ 3)
(Ⓐ 1 – Ⓑ 2)
(Ⓐ 4 – Ⓑ 1)

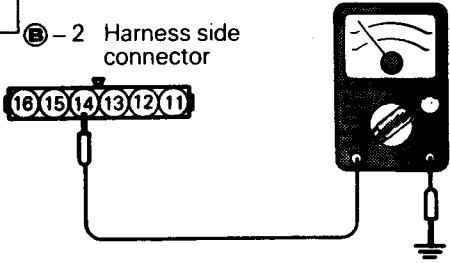
5  **ⓑ** - 2 Harness side connector

7FU0700

Check for continuity of the earth circuit

- Connector: Disconnected

OK → **6**

✗ → Repair the harness. (**ⓑ**14 - Earth)

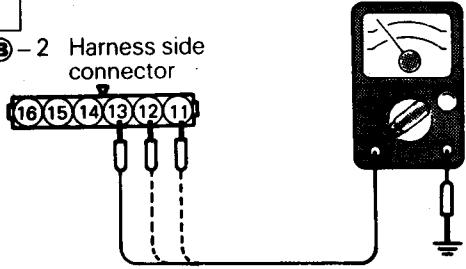
6  **ⓑ** - 2 Harness side connector

7FU0701

Measure the voltage of the control signal circuit of the power transistor.

- Connector: Disconnected
- Ignition switch: START

Voltage (V)
0.5 - 4.0

OK → **7**

✗ → Repair the harness.
 (**ⓑ**13 - 10)
 (**ⓑ**12 - 23)
 (**ⓑ**11 - 11)

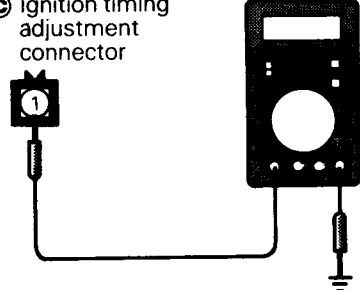
7  **Ⓒ** Ignition timing adjustment connector

7FU1060

Measure the voltage of the ignition timing adjustment terminal.

- Ignition switch: ON

Voltage (V)
4.0 - 5.2

OK → 

✗ → Repair the harness. (**Ⓒ** 1 - 52)

PURGE CONTROL SOLENOID VALVE

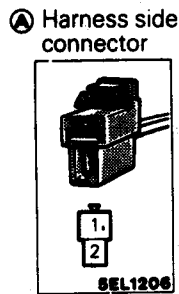
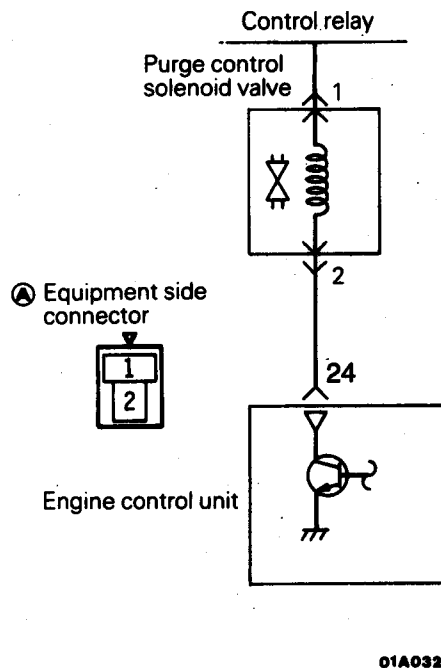
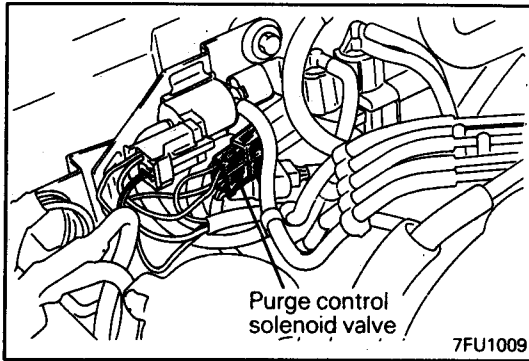

Engine control unit connector

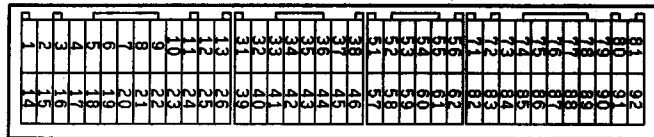

9FU0393

HARNESS INSPECTION

1

A Harness side connector
B Control relay harness side connector
7FU2472

Check for continuity between purge control solenoid valve and control relay.

- Purge control solenoid valve connector: Disconnected
- Control relay connector: Disconnected

NOTE
Touch the ohmmeter probes to both ends of the harness

OK → **2**

✗ → Repair the harness. (A 1-B 1)

2

A Harness side connector
Engine control unit harness side connector
9FU0040

Check for an open-circuit, or a short-circuit to earth, between the purge control solenoid valve and the engine control unit.

- Purge control solenoid valve connector: Disconnected
- Engine control unit connector: Disconnected

OK → STOP

✗ → Repair the harness. (A 2-9)

EGR CONTROL SOLENOID VALVE

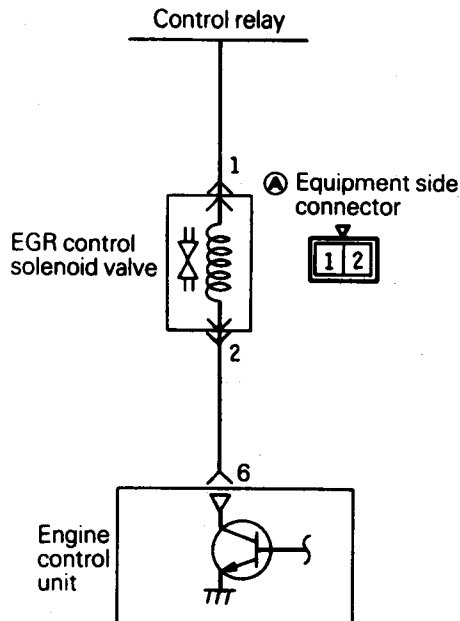
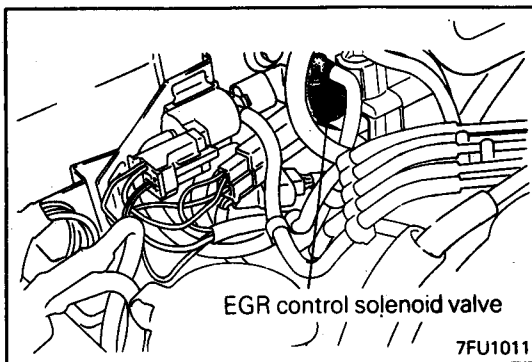

01W667

Engine control unit connector

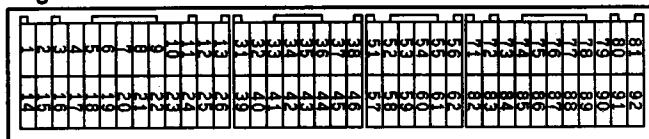

9FU0393

HARNESS INSPECTION

1

① Harness side connector

② Harness side connector

7FU2470

Check for continuity between EGR control solenoid valve and control relay

- EGR control solenoid valve connector: Disconnected
- Control relay connector: Disconnected

NOTE
Touch the ohmmeter probes to both ends of the harness

OK →

✗ →

2

Repair the harness.
(A 1 - B 1)

2

① Harness side connector

Engine control unit harness side connector

6

01A0825

Check for an open-circuit, or a short-circuit to earth, between the EGR control solenoid valve and the engine control unit.

- EGR control solenoid valve connector: Disconnected
- Engine control unit connector: Disconnected

OK →

✗ →

STOP

Repair the harness.
(A 2 - 6)

FUEL PRESSURE CONTROL VALVE

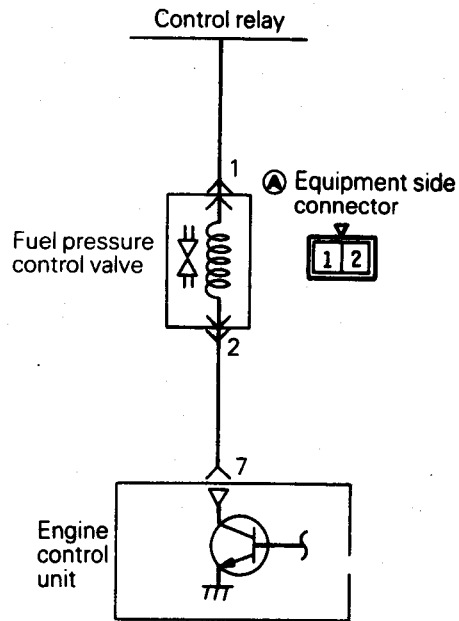
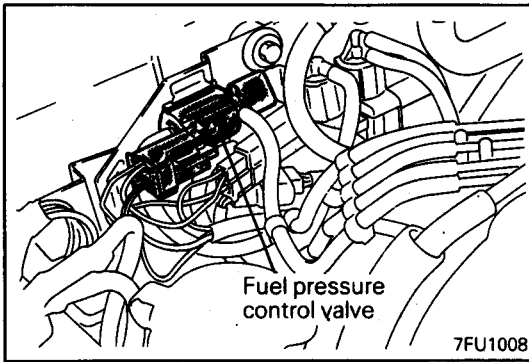

01W667

Engine control unit connector

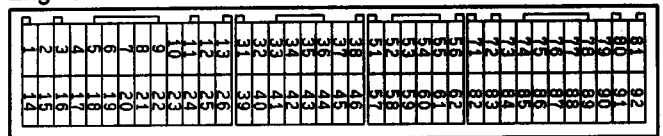

9FU0393

HARNESS INSPECTION

1

① Harness side connector
② Harness side connector

7FU2470

Check for continuity between fuel pressure control solenoid valve and control relay

- Fuel pressure control solenoid valve connector: Disconnected
- Control relay connector: Disconnected

NOTE
Touch the ohmmeter probes to both ends of the harness

OK → **2**

✗ → Repair the harness.
(A 1 - B 1)

2

① Harness side connector
Engine control unit harness side connector

01A0825

Check for an open-circuit, or a short-circuit to earth, between the fuel pressure control solenoid valve and the engine control unit.

- Fuel pressure control solenoid valve connector: Disconnected
- Engine control unit connector: Disconnected

OK → **STOP**

✗ → Repair the harness.
(A 2 - 7)

WASTE GATE CONTROL SOLENOID VALVE

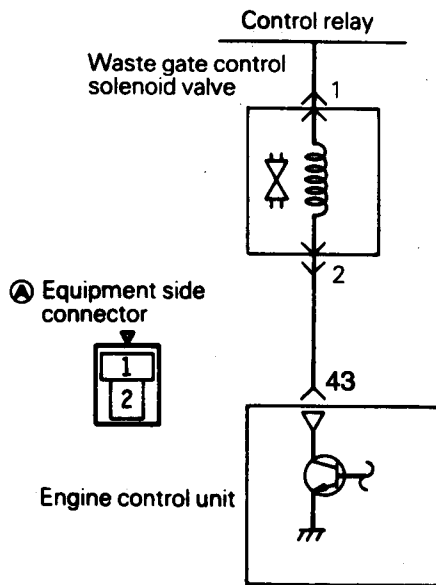
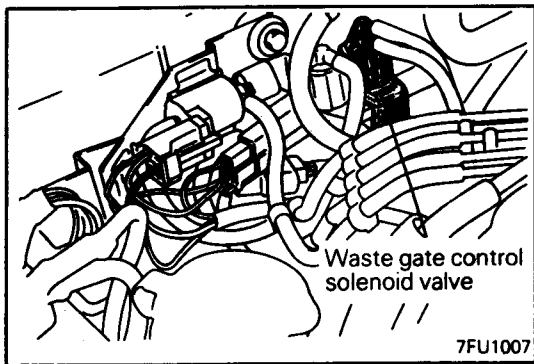

01A0324

Engine control unit connector

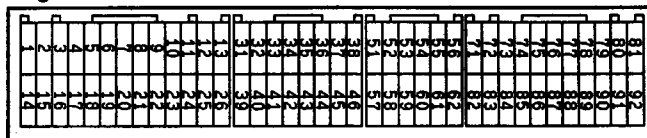

9FU0393

HARNES INSPECTION

1

Ⓐ Harness side connector

Ⓑ Control relay harness side connector

7FU2472

Check for continuity between waste gate control solenoid valve and control relay.

- Waste gate control solenoid valve connector: Disconnected
- Control relay connector: Disconnected

NOTE
Touch the ohmmeter probes to both ends of the harness

OK → **2**

✗ → Repair the harness. (A 1-B 1)

2

Ⓐ Harness side connector

Engine control unit harness side connector 9FU0040

Check for an open-circuit, or a short-circuit to earth, between the waste gate control solenoid valve and the engine control unit.

- Waste gate control solenoid valve connector: Disconnected
- Engine control unit connector: Disconnected

OK → STOP

✗ → Repair the harness. (A 2 - 43)

BOOST METER

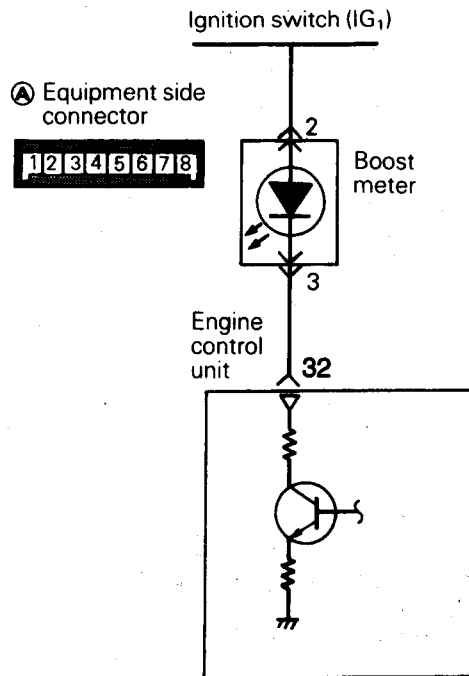
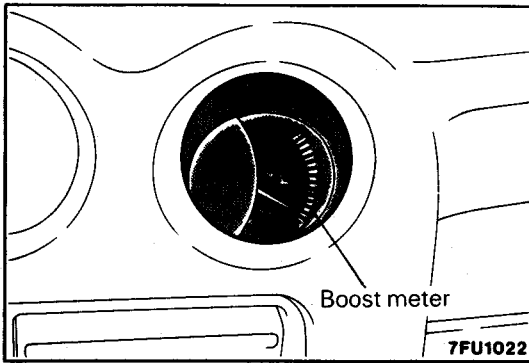

Engine control unit connector

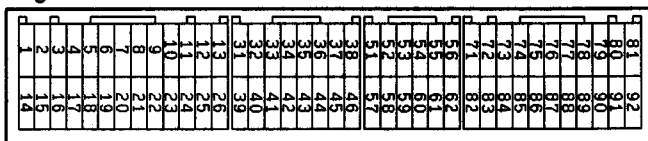

9FU0393

7FU0985

HARNESS INSPECTION

1

Ⓐ Harness side connector

7FU0986

Measure the power supply voltage.

- Connector: Disconnected
- Ignition switch: ON

Voltage (V)
SV

OK → **2**

✗ → Repair the harness.
Ⓐ **2** – Ignition coil (IG)

2

Ⓐ Harness side connector

7FU0987

Check for an open-circuit or a short-circuit to earth between the engine control unit and the boost meter.

- Boost meter connector: Disconnected
- Engine control unit connector: Disconnected

OK → **STOP**

✗ → Repair the harness.
Ⓐ **3** – **32**

ANTI-LOCK BRAKING SIGNAL

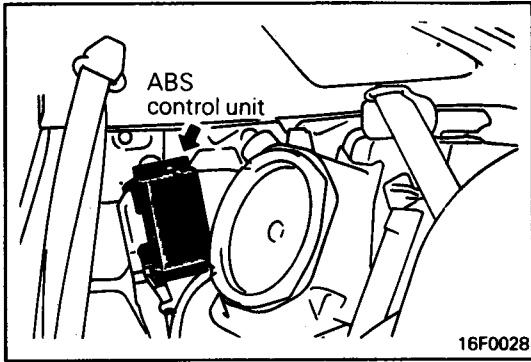

Ⓐ ABS control unit equipment side connector



Engine control unit connector

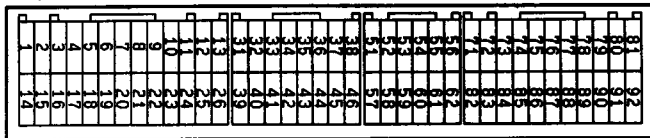

9FU0393

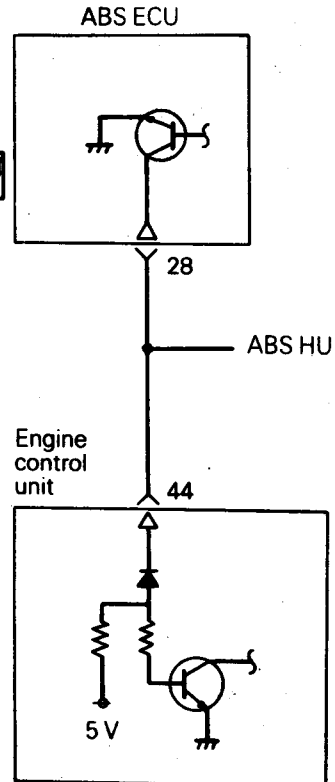

6FU1542

TERMINAL VOLTAGE CHECK CHART

Engine Control Unit Connector Terminal Configuration

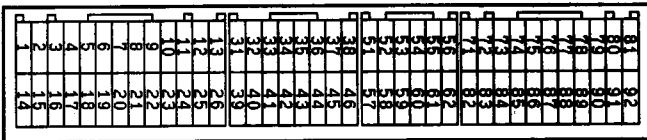

9FU0393

Terminal No.	Check point	Check conditions (Engine conditions)	Standard value	Remarks
80	Back-up power supply	Ignition switch: OFF	SV	
12	Power supply	Ignition switch: ON	SV	
25				
82	Ignition switch IG	Ignition switch: ON	SV	
38	Control relay (power supply)	Ignition switch: OFF	SV	
		Ignition switch: ON	0 – 3V	
22	Control relay (fuel pump)	Ignition switch: ON	SV	
		Engine: Running at idle	0 – 3V	
81	Sensor impressed voltage	Ignition switch: ON	4.5 – 5.5V	

Terminal No.	Check point	Check conditions (Engine conditions)		Standard value	Remarks
90	Air flow sensor	Engine: Running at idle		2.2–3.2V	
		Engine speed: 2,000 r/min			
19	Air flow sensor reset signal	Engine: Running at idle		0–1V	
		Engine speed: 3,000 r/min		6–9V	
72	Intake air temperature sensor	Ignition switch: ON	When intake temperature is 0°C (32°F)	3.2–3.8V	
			When intake temperature is 20°C (68°F)	2.3–2.9V	
			When intake temperature is 40°C (104°F)	1.5–2.1V	
			When intake temperature is 80°C (176°F)	0.4–1.0V	
85	Barometric pressure sensor	Ignition switch: ON	When altitude is 0 m (0 ft.)	3.7–4.3V	
			When altitude is 1,200 m (3,937 ft.)	3.2–3.8V	
83	Water temperature sensor	Ignition switch: ON	When water temperature is 0°C (32°F)	3.2–3.8V	
			When water temperature is 20°C (68°F)	2.3–2.9V	
			When water temperature is 40°C (104°F)	1.3–1.9V	
			When water temperature is 80°C (176°F)	0.3–0.9V	
84	Throttle position sensor	Ignition switch: Kept in ON state for more than 15 seconds	Throttle valve placed in idle position	0.3–1.0V	
			Throttle valve placed in fully opened position	4.5–5.5V	
87	Idle position switch	Ignition switch: ON	Throttle valve placed in idle position	0–1V	
			Throttle valve placed in slightly opened position	4V or more	
88	Cam position sensor	Engine: Cranked		0.2–3.0V	
		Engine: Running at idle			
89	Crank angle sensor	Engine: Cranked		0.2–3.0V	
		Engine: Running at idle			
71	Ignition switch–ST	Engine: Cranked		8V or more	
86	Vehicle speed sensor	<ul style="list-style-type: none"> ● Ignition switch: ON ● Move the vehicle slowly forward 		0 ↔ 5V (Changes repeated)	
37	Power steering fluid pressure switch	Engine: Running at idle after warmup	Steering wheel placed in neutral (straight ahead) position	SV	
			Steering wheel turned half a turn	0–3V	

Terminal No.	Check point	Check conditions (Engine conditions)		Standard value	Remarks
45	Air conditioner switch 1	Engine: Running at idle	Airconditioner switch set to OFF	0-3V	
			Airconditioner switch set to ON (Airconditioner compressor in driven state)	SV	
57	Air conditioner switch 2	Engine: Running at idle	Airconditioner switch set to OFF	0-3V	
			<ul style="list-style-type: none"> ● Airconditioner switch set to ON ● Indoor set temperature brought closer to atmospheric temperature 	SV	
8	Air conditioner relay	<ul style="list-style-type: none"> ● Engine: Running at idle ● Airconditioner switch: OFF → ON (Air compressor in driven state) 		SV or 6V or more for a moment → 0-3V	
21	Fan motor relay (Lo)	Radiator fan not operating (Coolant temperature: below 90°C [194°F])		B+	
		Radiator fan operating at low speeds (Coolant temperature: 95 - 105°C [203 - 221°F])		0-3V	
20	Fan motor relay (Hi)	Radiator fan not operating (Coolant temperature: below 90°C [194°F])		B+	
		Radiator fan operating at high speeds (Coolant temperature: above 105°C [221°F])		0-3V	
55	Electric load switch	Engine: Running at idle	Lighting switch set to OFF	0-3V	
			Lighting switch set to ON	SV	
76 75	Oxygen sensor	Engine: Kept running at 2,000 r/min after warmup (Digital voltmeter to be used for checking)		0 ↔ 0.8V (Changes repeated)	Terminal 55 for rear bank
1	No. 1 injector	Engine: Running at idle after warmup, and accelerated abruptly by depressing accelerator pedal		Falls temporarily a little from 11-14V.	
14	No. 2 injector				
2	No. 3 injector				
15	No. 4 injector				
3	No. 5 injector				
16	No. 6 injector				
4	Stepper motor coil <A1>	Engine: Just after the warmed-up engine has started (for 1 minute)		SV ↑ ↓ 0-3V (Changed repeated)	
17	Stepper motor coil <A2>				
5	Stepper motor coil <B1>				
18	Stepper motor coil <B2>				

Terminal No.	Check point	Check conditions (Engine conditions)		Standard value	Remarks
10	Power transistor unit A	Engine speed: 3,000 r/min		0.3 – 3V	
23	Power transistor unit B				
11	Power transistor unit C				
24	Purge control solenoid valve	Ignition switch: ON		SV	
		Start the warmed-up engine and keep the engine speed at 3,000 r/min		0 – 3V	
7	Fuel pressure control valve	Ignition switch: ON		SV	
		Engine: From cranking to idling (within approx. 2 minutes)		0 – 3V ↓ SV	
43	Waste gate solenoid valve	Ignition switch: ON		SV	
		Engine: Idling (when the premium gasoline is used)		0 – 3V	
32	Turbo meter	Ignition switch: ON		4 – 13V	
		Engine: Depress the accelerator pedal abruptly while the engine is idling		Falls temporarily from SV	
35	Fuel pump relay 2	Engine: Depress the accelerator pedal abruptly while the engine is idling		Rises temporarily from 0 – 3V	
58	Engine ignition signal	Engine: 3,000 rpm		0.3 – 3V	
52	Ignition timing adjustment terminal	Ignition switch: ON	Ignition timing adjustment terminal connected to earth	0 – 1V	
			Ignition timing adjustment terminal disconnected from earth	4.0–5.5V	
36	Engine warning lamp	Ignition switch: OFF → ON		0 – 3V ↓ 9 – 13V (Several seconds later)	
6	EGR control solenoid valve	Ignition switch: ON		SV	
		Engine: Running at idle and accelerated abruptly by depressing accelerator pedal		Falls temporarily from SV.	
44	Anti-lock braking signal	Engine: Running at idle		SV	
		<ul style="list-style-type: none"> When vehicle is started in motion for the first time after the ignition switch was placed in ON position Vehicle speed: 0 → 10 km/h (0 → 0.6 mph) 		SV ↓ 0 – 3V (for a moment)	

GROUP 54 CHASSIS ELECTRICAL

GENERAL

OUTLINE OF CHANGE

The following service procedures have been changed and the system has been changed from an option to standard equipment to correspond to changes in the immobilizer-ECU.

- Troubleshooting
- ID code registration method

IGNITION SWITCH AND IMMOBILIZER SYSTEM

TROUBLESHOOTING

INSPECTION CHART FOR DIAGNOSIS TROUBLE CODES

Diagnosis code No.	Inspection items	Reference page
11	Transponder communication system	54-1
12	ID codes are not the same or are not registered	54-2

INSPECTION PROCEDURE FOR DIAGNOSIS TROUBLE CODES

Code No. 11 Transponder communication system	Probable cause
The ID code of the transponder is not sent to the immobilizer-ECU immediately after the ignition switch is turned to the ON position.	<ul style="list-style-type: none"> • Malfunction of transponder • Malfunction of ignition key ring antenna • Malfunction of harness or connector • Malfunction of immobilizer-ECU

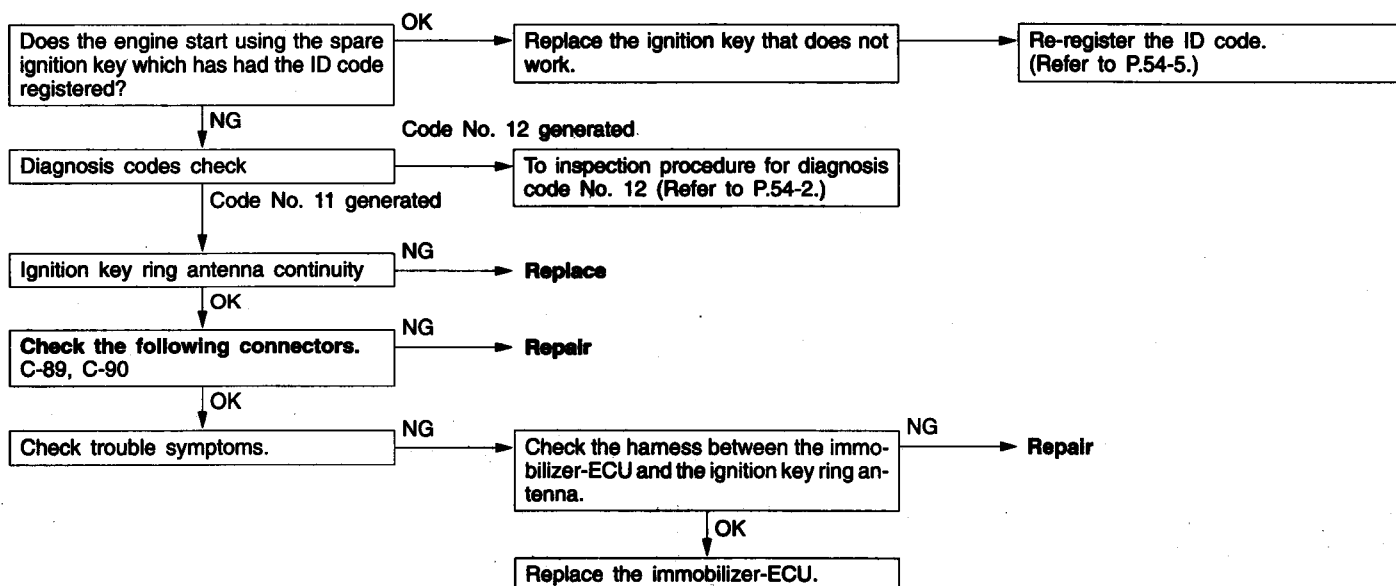

Code No. 12 ID codes are not the same or are not registered	Probable cause
The ID code which is sent from the transponder is not the same as the ID code which is registered in the immobilizer-ECU.	<ul style="list-style-type: none"> • The ID code in the ignition key being used has not been properly registered. • Malfunction of immobilizer-ECU



INSPECTION CHART FOR TROUBLE SYMPTOMS

Trouble symptom	Inspection procedure No.	Reference page
Communication with the MUT-II is not possible	1	54-2
Diagnosis code No. 54 has been generated by the engine-ECU	2	54-3
ID code cannot be registered using the MUT-II	3	54-3
Engine does not start (turns over but does not ignite)	4	54-4
Immobilizer-ECU power circuit and earth circuit check	5	54-4

INSPECTION PROCEDURE FOR TROUBLE SYMPTOMS

Inspection Procedure 1

Communication with the MUT-II is not possible.	Probable cause
The cause is probably a malfunction of the diagnosis line or the immobilizer-ECU is not functioning.	<ul style="list-style-type: none"> • Malfunction of diagnosis line • Malfunction of harness or connector • Malfunction of immobilizer-ECU

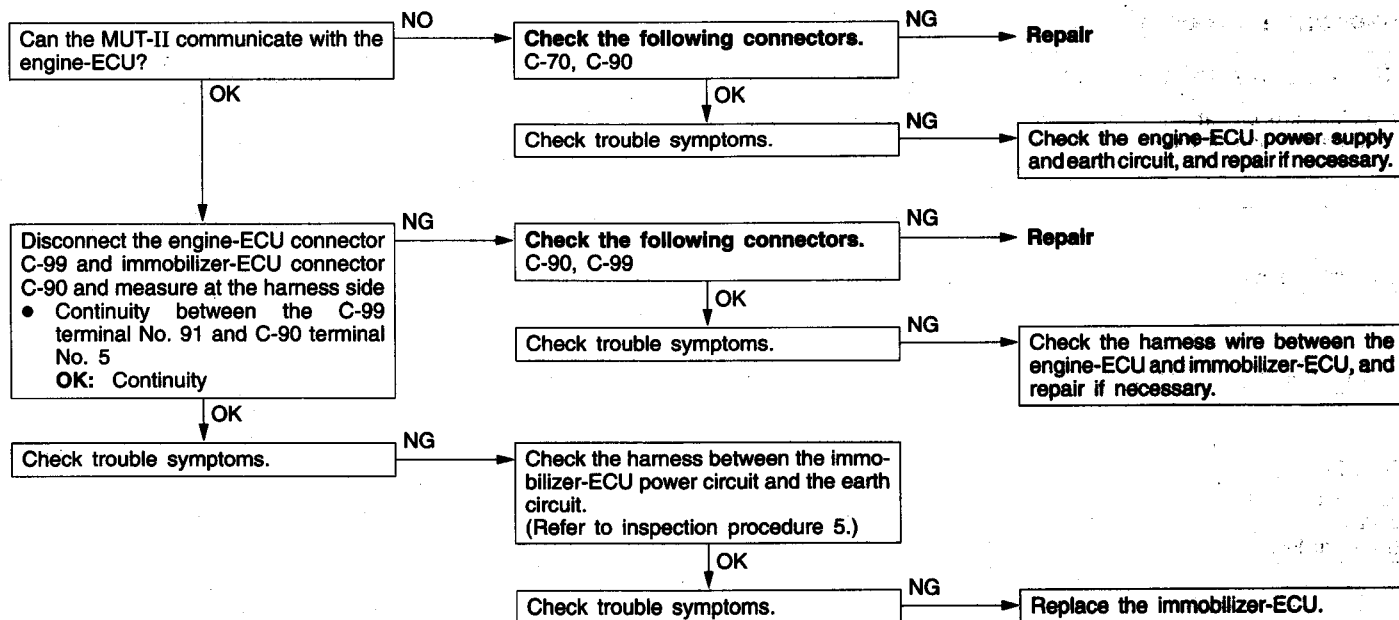

Inspection Procedure 2

Diagnosis code No. 54 has been generated by the engine-ECU.	Probable cause
There is a problem with communication between the engine-ECU and the immobilizer-ECU.	<ul style="list-style-type: none"> ● Malfunction of harness or connector ● Malfunction of immobilizer-ECU ● Malfunction of engine-ECU

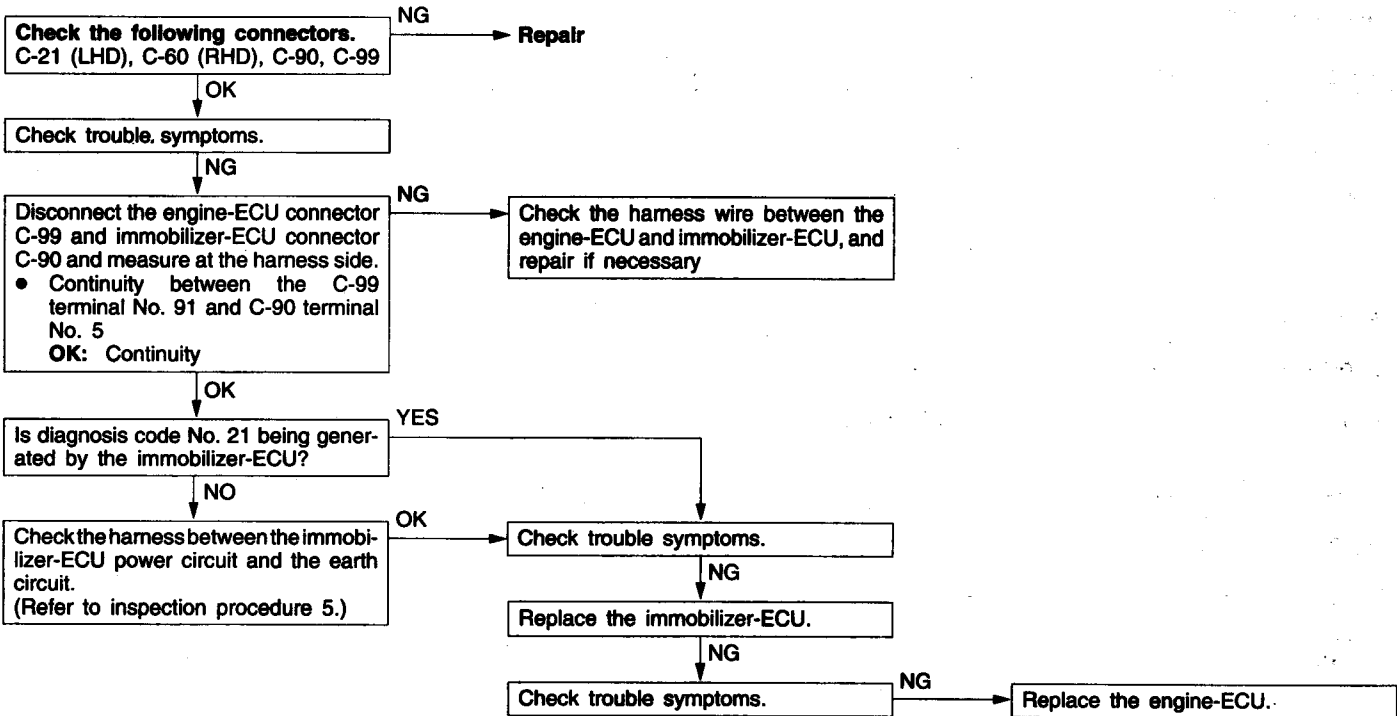

Inspection Procedure 3

ID code cannot be registered using the MUT-II.	Probable cause
The cause is probably that the immobilizer-ECU cannot read the ID code, or there is a malfunction of the immobilizer-ECU.	<ul style="list-style-type: none"> ● Malfunction of transponder ● Malfunction of ignition key ring antenna ● Malfunction of harness or connector ● Malfunction of immobilizer-ECU

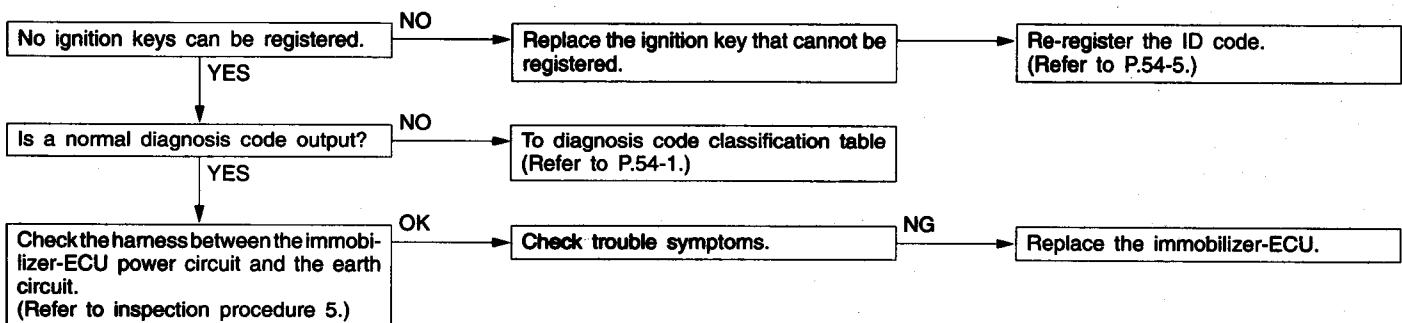

Inspection Procedure 4

Engine does not start (turns over but does not ignite)	Probable cause
If the fuel injectors are not operating, there might be a problem with the MPI system in addition to a malfunction of the immobilizer system. It is normal for this to occur if an attempt is made to start the engine using a key that has not been properly registered.	<ul style="list-style-type: none"> ● Malfunction of MPI system ● Malfunction of immobilizer system

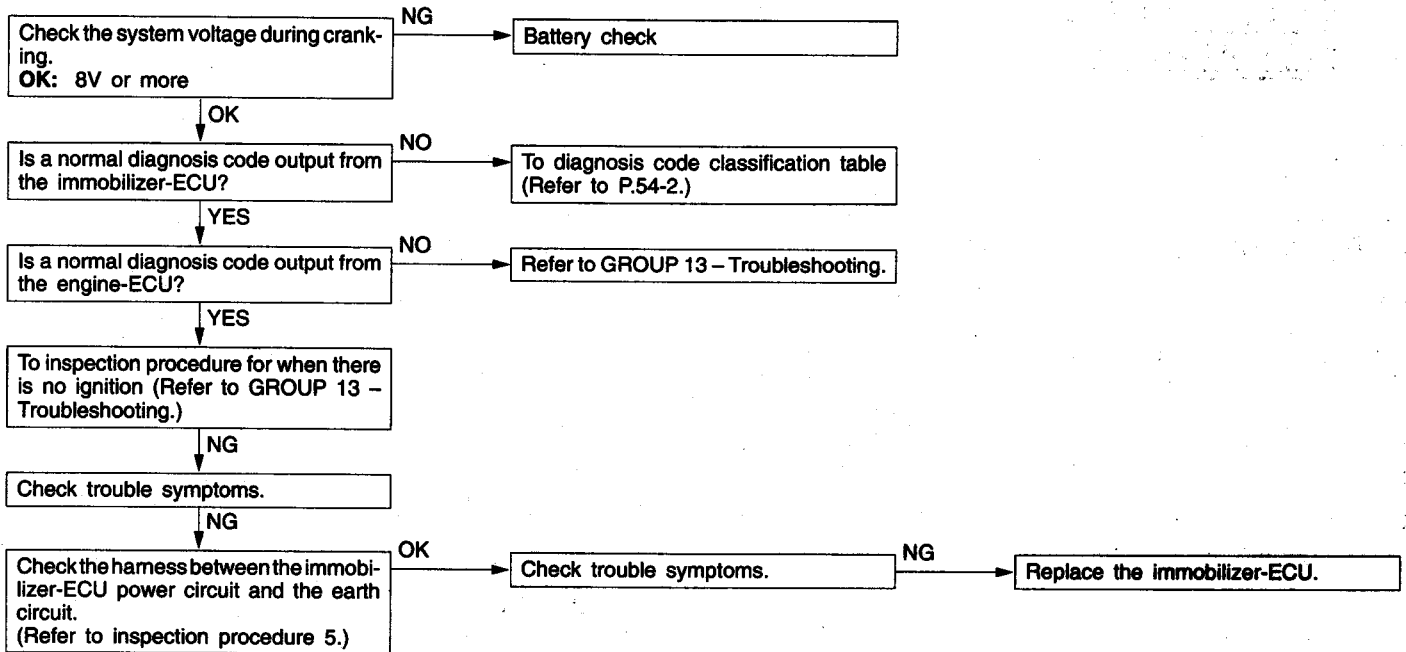

Inspection Procedure 5

Immobilizer-ECU power circuit and earth circuit check

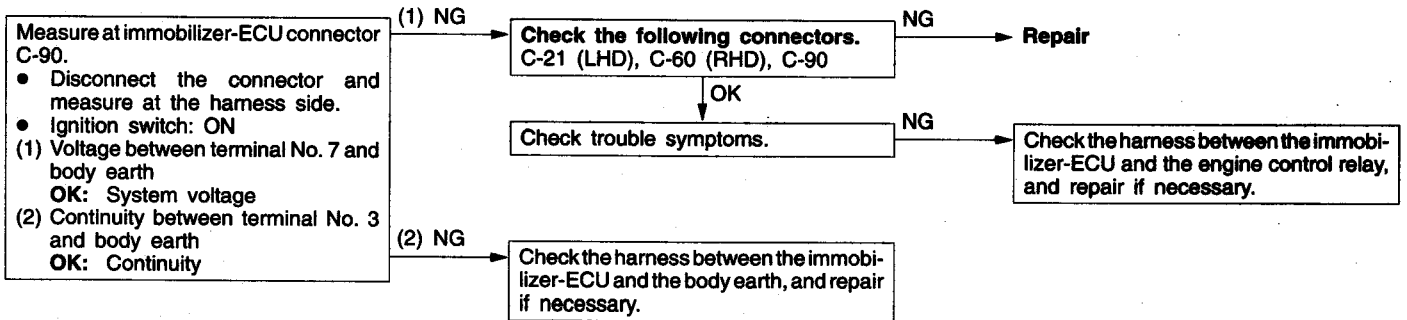

CHECK AT IMMOBILIZER-ECU

TERMINAL VOLTAGE CHECK CHART

1	2		3	4	5	
6	7	8	9	10	11	12

20F0191

Terminal No.	Signal	Check requirements	Terminal voltage
3	Immobilizer-ECU earth	–	0V
7	Immobilizer-ECU power supply	Ignition switch: ON	System voltage
		Ignition switch: Within 5 seconds after changing from ON to OFF	
		Ignition switch: OFF, or 5 seconds after changing from ON to OFF	0V

IGNITION SWITCH

ID CODE REGISTRATION METHOD

If using an ignition key that has just been newly purchased, or if the immobilizer-ECU has been replaced, you will need to register the ID codes for each ignition key being used into the immobilizer-ECU. (A maximum of eight different ID codes can be registered.)

Moreover, when the immobilizer-ECU has been replaced, you will need to use the MUT-II to register the password that the user specifies into the immobilizer-ECU. (Refer to the "MUT-II REFERENCE MANUAL" or "MUT-II OPERATING INSTRUCTIONS" on using the MUT-II.)

Caution

Because registering of the ID codes is carried out after all previously-registered codes have been erased, you should have ready all of the ignition keys that have already been registered.

1. Connect the MUT-II to the diagnosis connector.

Caution

Turn off the Ignition switch before connecting or disconnection of the MUT-II.

2. Check that the diagnosis code No. 54 is not being generated by the engine-ECU. If it is being generated check according to the Troubleshooting Procedures. (Refer to GROUP 13A – Troubleshooting.)
3. Use the ignition key that is to be registered to turn on the ignition switch.

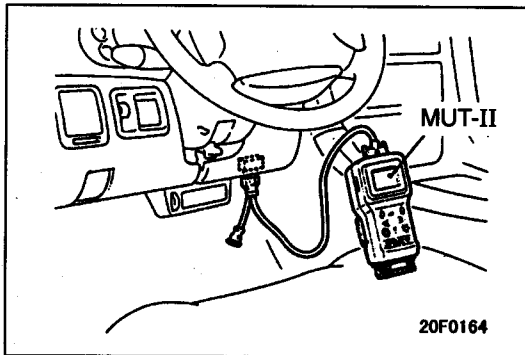

4. Use the MUT-II to register the ID code.
If you are registering two or more keys, pull out the first key and then insert the next key to be registered and turn the ignition switch to ON within 5 seconds, and without disconnecting the MUT-II.

NOTE

If more than 5 seconds pass, the engine control relay which supplies power to the immobilizer-ECU will turn off, and further registration will not be possible.

5. Turn off the ignition switch.
6. Check that the engine can be started with each of the ignition keys.
7. Check the diagnosis output from the engine-ECU, and erase code No. 54 if it appears. (Refer to GROUP 13A – Troubleshooting.)
8. Disconnect the MUT-II. This completes the registration operation.

NOTES

Pub. No. PWUE9119-H

Pub. No. PWUE9203-6

**ENGLISH
EUROPE AND EXPORT**